

# Rosicrucian Digest

April 1978 • 75c



*Featuring:*

• **Mysticism**

• **Science**

• **The Arts**

**The Destruction of Two Ancient Libraries-  
Alexandrian and Mayan**

**Secrets of Pyramid and Sphinx Revealed**

**Magnetic Energy of the Brain**

World  
**ROSICRUCIAN**  
Convention

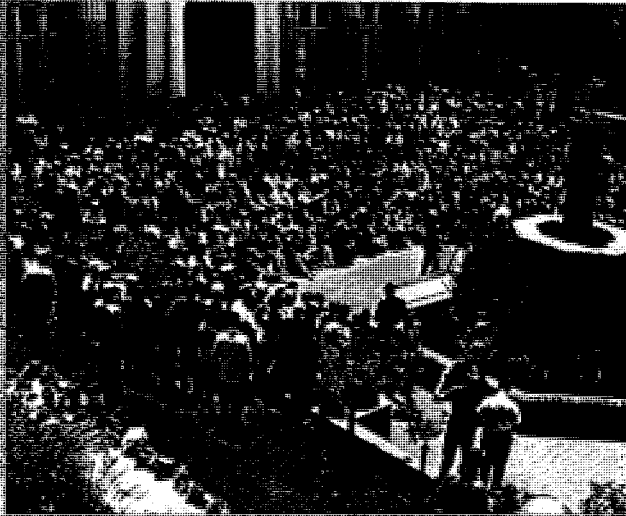
1978

July 9 - 14

Join us at

**Rosicrucian Park**

**San Jose**



You will experience many interesting and inspiring events during the 1978 International Convention in San Jose. Many hundreds of members from all parts of the world will join together to enjoy and participate in inspiring Temple Convocations—Degree Classes—demonstrations of Rosicrucian principles—dramatic presentations and Rosicrucian Forums. Visit the Rosicrucian Egyptian Museum and Planetarium and attend the Convention Banquet.

### **Six Wonderful Days**

Come and meet with your fellow officers and members and share in the unique experience of a Rosicrucian International Convention—enjoy the serenity of beautiful Rosicrucian Park. Make your trip an unforgettable one.

**PLAN NOW — MAKE YOUR RESERVATIONS EARLY!**



Write for details to:

**Convention Secretary**

Psychic  
Phenomena  
In Crisis



## On the Threshold of Danger— Strange Things Happen!

HAVE YOU ever sensed the imminent danger of a loved one—even though he is across sea or continent? Have you been suddenly awakened by the call of your name—*then realize* that the one who spoke it was thousands of miles distant? If you ever had these experiences—as millions now have—learn the truth about them.

*Love and friendship* create a bond of consciousness between humans. This consciousness can be extended to bridge the voids of time and space. When human souls are bared under great *emotional stress*, then this *indwelling faculty* is released. Learn that there is far more to life, to the fullness and glory of living, than you suspect.

### Accept This FREE Book

Let the Rosicrucians, a world-wide organization of thinking men and women (not a religion), show you that material limitations need not actually separate you from those you love. Convert the mysteries of your being into intelligible, usable laws of accomplishment. Write today for *free copy* of the book *The Mastery of Life*. It will explain how you may share these strange truths of self. Address Scribe: S.P.C. 10.

## The ROSICRUCIANS

SAN JOSE (AMORC) CALIFORNIA 95191



# Rosicrucian Digest

Published Monthly by the Supreme Council  
of the ROSICRUCIAN ORDER, AMORC  
Rosicrucian Park, San Jose, CA 95191

Robin M. Thompson, Editor

Official Magazine of the  
Worldwide Rosicrucian Order

April, 1978, Vol. LVI No. 4

## CONTENTS

- 4 Thought of the Month: *Secrets of Pyramid and Sphinx Revealed*
- 8 India's Spiritual Fair
- 12 The Celestial Sanctum: *The Mystical Life*
- 14 The Destruction of Two Ancient Libraries: Alexandrian and Mayan
- 17 Medifocus: *King Hussein of Jordan*
- 18 Mindquest: *Magnetic Energy of the Brain*
- 25 Carl Jung and the Magicians' Fire
- 28 Going Back?
- 31 The Mystical Arts
- 33 Don't Despair!—A Mystical Approach to Overcoming Depression
- 35 Rosicrucian Activities Around the World

## PHOTO PAGES

- Cover Jaguar Temple (*see page 24*)
- 3 African Dignitary Visits AMORC
- 37 The Historical Seine River
- 38 Shrine at Dendera Temple

**SUBSCRIPTION:** \$7.00\* per year, single copies 5¢. **ADDRESS:** *Rosicrucian Digest*, Rosicrucian Park, San Jose, CA 95191, U.S.A. Changes of address must reach us by the first of the month preceding date of issue. Entered as Second-Class matter at the Post Office at San Jose, Calif., under Section 1103 of the U.S. Postal Act of October 3, 1917. Second Class postage paid at San Jose, Calif. Statements made in this publication are not the official expression of the organization or its officers, unless declared to be official communications.

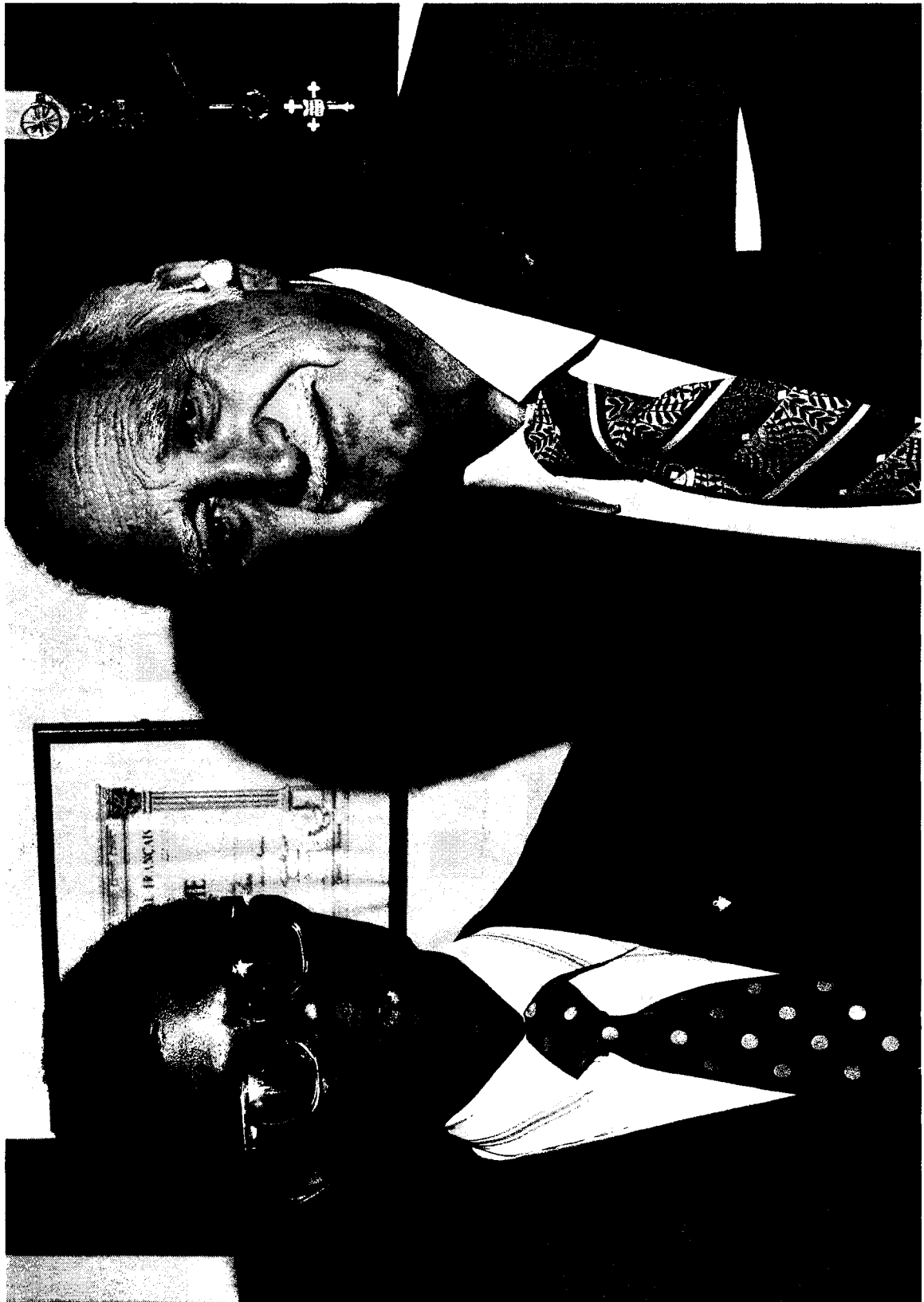
\*Other Currencies  
£4.40 A\$7.00 NZ\$7.00  
¥4.65 ¥8.75 R6.10

## AFRICAN DIGNITARY VISITS AMORC

Frater Ebenezer O. Ajayi (left) is shown here with Emperor Ralph Lewis in the latter's office. Frater Ajayi is Past Master of Isis Lodge, AMORC, in Lagos, Nigeria. Isis Lodge has one of the largest memberships of any Rosicrucian Lodge in the world. It numbers many hundreds of Rosicrucian students.

(Photo by AMORC)

Copyright 1978, by the Supreme Grand Lodge of AMORC, Inc. All rights reserved. Republication of any portion of *Rosicrucian Digest* is prohibited without prior written permission of the publisher.



## SECRETS OF PYRAMID AND SPHINX REVEALED

BEHIND EVERY TRADITION that has persistently withstood time, there lie some elements of truth. These elements of truth, in being transmitted from one culture to another, may suffer the accretion of exaggeration. However, most all of these traditions are worthy of a serious investigation. For centuries, the references in Homer's poem, *The Iliad*, to Troy and its wars were considered mostly to be myth. It was not until Heinrich Schliemann uncovered and explored the ruin-heap at Hissarlik in Asia Minor (1870-1879) that there was revealed proof of ancient Troy and the culture that preceded it.

Many are the tales that descend from antiquity about the pyramids of Egypt, and in particular the Great Sphinx. Down

through the centuries, not only the common people of the waves of civilization that swept over Egypt stood in awe before the colossal structures, but also world conquerors stood before them in wonderment and sought to fathom their mystery. Napoleon had his engineers and mathematicians estimate the bulk of the Great Pyramid at Gizeh. They could arrive at its physical proportions, but just *why* certain chambers within it were built and *why* there is an empty sarcophagus (coffin) in the so-called King's Chamber has never been evidentially established by its investigators.

The Sphinx, too, has looked down through centuries from its regal height upon the curious humanity who look up at its enigmatic face, wondering *why*.

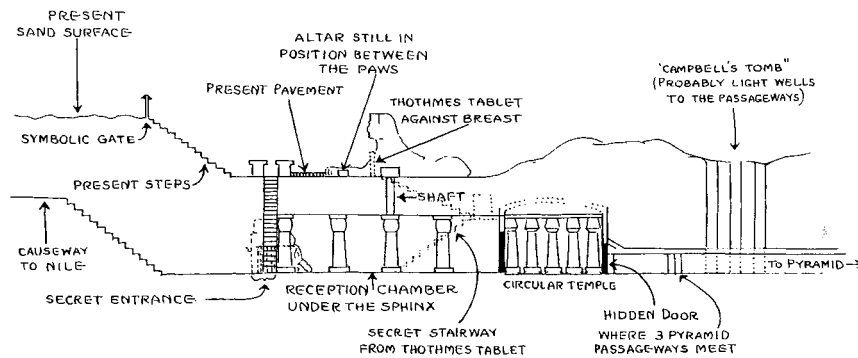


Diagram of subterranean halls beneath Great Sphinx

Egyptologists explain that it is a colossal statue of the king who built the second pyramid at Gizeh, and is carved from a large promontory of rock. Others relate it was intended as a statue of the Sun god.

However, legends, tales, and secret accounts elaborate upon the significance of the Sphinx and its relationship to the Great Pyramid. In particular the ancient mystery schools of Egypt told of its *initiatory* purpose. These accounts are not only verbal but have been secreted in their archives in written form. Sometime in the remote past, they were reduced to written form but not profaned by any general disclosure. Only by word of mouth did the mystical initiatory functions of the Sphinx reach the ears of modern man.

Over forty years ago (1936), in his book, *The Symbolic Prophecy of the Great Pyramid*, Dr. H. Spencer Lewis gave an account of what the mystery schools had to relate about the Great Pyramid and the Sphinx. He was privileged in gaining this information from a representative of the Egyptian mystery schools because of the Rosicrucian Order, AMORC's, traditional relationship with an ancient mystery school of that land.

We quote in part from Dr. Lewis' book:

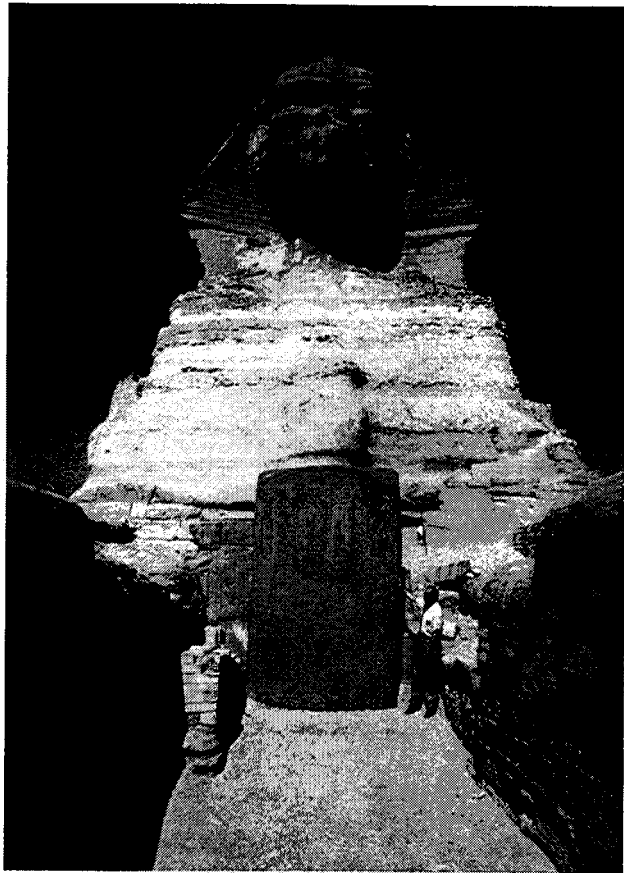
"For centuries there was a whispered story to the effect that there was a ceremonial court or courtyard in front of the Sphinx, buried beneath the sands, in which court initiation ceremonies were held prior to the entrance into the Pyramid. For centuries this whispered story was ridiculed by geologists and some historians and by many of the natives and officials of Egypt. However, in recent years the sand around, and especially in front of, the Sphinx has been removed revealing a very beautiful pavement of a courtyard between the paws and in front of the breast of the Sphinx, and in the center of this court, a symbolical altar such as had no use in any of the priesthood religions of Egypt but was known to have its place in the temples of mystery for initiation ceremonies. . . .

"Another of the traditions was to the effect that a great movable stone or slab in front of the breast of the Sphinx, between its paws, blocked the entranceway to a secret passage that ran beneath the Sphinx and beneath the sands to the center of the Great Pyramid, and that this long passageway was the secret ceremonial passageway from the outer court in front of the Sphinx to the rising passageways and chambers in the Pyramid itself."

(continued overleaf)

---

*The Great Sphinx has looked across centuries of time. Over 4800 years old, the Sphinx has been covered by drifting sands for most of those centuries. However, at various times in history the sands have been cleared away. In this photograph Imperator Ralph M. Lewis points to the great stele against the breast of the Sphinx. This stele records the legendary story of how Thutmose IV became Pharaoh of Egypt. Not designated as successor to his illustrious father, Amenhotep II, the young man was told by the Sun god in a dream that if he would clear away the drifting sands then covering the Great Sphinx, he would become Pharaoh. Thutmose vowed to remove the sands, did so, and many years later, following his father's death, became the next Pharaoh of Egypt. The head and body of this ancient monument are carved from solid rock.*



Of the schematic drawings shown on page four, Dr. Lewis said:

"These unusual drawings (only one is shown here) were made from secret manuscripts possessed by archivists of the mystery schools of Egypt and the Orient and are part of secret manuscripts telling of the ancient forms of initiations held in the Sphinx and Great Pyramid. The existence of these subterranean halls, such as the one beneath the Sphinx and indicated in the second diagram (the one shown), and the passageways and other features has been denied repeatedly by Egyptian and other authorities and even by eminent archaeologists and investigators from various parts of Europe. So persistent have been these denials that the claims of the representatives of the mystery schools have been looked upon by the public as pieces of fiction, deliberately invented and periodically whispered in order to mystify visitors to Egypt. In fact, the attitude of scientists is typified by the expression of one of them who said: 'No one should pay any attention to the preposterous claims in regard to the interior of the Pyramid or the presumed passageways and unexcavated temples and halls beneath the sand in the Pyramid district made by those who are associated with the so-called secret cults or mystery societies of Egypt and the Orient.'"

But this derision of the accounts of the mystery schools of Egypt, as quoted by Dr. Lewis, was years ago! *What of today?* Do scientists still consider as fantastic such accounts as are related in Dr. Lewis' book?

#### **Stanford Research Institute**

An answer to this lies in the fact that just a few years ago the Stanford Research Institute of Stanford University in California sent physicists and electronic experts with highly sophisticated instruments to probe the Great Pyramid! They were to project electronic beams through apparently solid areas of the Great Pyramid to determine if there were any chambers not presently known to exist.

Subsequently, they reported in archaeological and other journals that they had as yet no evidence of such chambers. However, the scientists further stated that they were not satisfied with their tests because they felt that their present equipment was not adequate enough to be considered conclusive of their efforts. They expressed their intention, with the approval of Egyptian authorities, to pursue their search further. It must be realized that these men who conducted this scientific search were not given to fantasy but sought empirical proof of



**Within the King's Chamber of the Great Pyramid. It was here that the initiates of the ancient mystery schools were "raised" into a new life of greater illumination. Emperor of the Rosicrucian Order, AMORC, Ralph M. Lewis, in this exceptional photograph, shows the position of the ancient initiator before the sarcophagus.**

what to them had been fantasies, or at best just traditions. Their continued efforts are indications that they are convinced of the *probability* of what they seek.

In the interim before these scientists began their further explorations and tests, we had the visit of an Egyptian authority who presides over the Gizeh area in which the Great Pyramid and the Sphinx are located. This gentleman visited not only our Rosicrucian Egyptian Museum, displaying the largest collection of its kind on the Pacific Coast, but certain of our laboratories as well. He was well acquainted with the accounts of the subterranean passageways mentioned by Dr. Lewis some forty years ago. On the occasion of his visit, he was told about the statement that Dr. Lewis had made in his book about a passageway existing between the Sphinx and the Great Pyramid.

AMORC was asked to financially assist the further investigations of the Stanford Research Institute by sending contribu-



tions. Unfortunately, at that time, because of other commitments, this was not possible. Now, however, we are pleased to report that Stanford Research Institute is to begin again, with more advanced technical instrumentation, the further exploring of the Sphinx for possible chambers and passageways connected with the Great Pyramid. We are happy to say that there will be present an eminent scientist and member of AMORC—however not a member of the Stanford Research Institute—who will report to

AMORC on the developments of the project and any discovery.

In the title of this article we mention, "Secrets Revealed"; they have not yet been *revealed*. However, if they are, the results will prove the accounts of the ancient mystery schools and statements made in Dr. Lewis' book as well. Let us further hope that this serious investigation will result in no further brushing away of traditions which are persistent, but which are thought to be incredulous without an equally serious investigation. △

***Worthy accomplishments can provide memory  
with a pleasure that counters the lessening  
satisfaction of age.***

—Validvar

### ***The Purpose of the Rosicrucian Order***

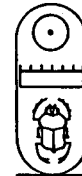
The Rosicrucian Order, which exists throughout the world, is a non-sectarian fraternal body of men and women devoted to the investigation, study, and practical application of natural and spiritual laws. The purpose of the organization is to enable everyone to live in harmony with the creative, constructive cosmic forces for the attainment of health, happiness, and peace. The Order is internationally known as the Ancient Mystical Order Rosae Crucis and, in America and all other lands, constitutes the only form of Rosicrucian activities united in one body. The A.M.O.R.C. (an abbreviation) does not sell its teachings. It gives them freely to affiliated members, together with many other benefits. For complete information about the benefits and advantages of Rosicrucian affiliation write a letter to the address below and ask for the free booklet, *The Mastery of Life*.

Address Scribe S.P.C.  
Rosicrucian Order, AMORC  
San Jose, California 95191, U.S.A.  
(Cable Address: "AMORCO")

### ***In Kind Appreciation . . .***

I wish to express my deep appreciation for the many flowers, cards, letters, and messages of condolence received from Rosicrucians and friends throughout the world. I regret that it is not possible to acknowledge all of the kind thoughts personally. Please accept my sincere thanks.

*Ralph M. Lewis*  
Imperator



# India's Spiritual Fair

---

by Thomas Parker, Ph.D.

AT A FAIR in the Western world we see the latest technological and material innovations, such as new refrigerators, furniture, automobiles, and electronic advances. India's giant fair, the *Maha Kumbha Mela*,\* is held approximately every twelve years, and is put together by thousands of organizations to demonstrate the best of their spiritual knowledge, their own particular ways of contacting God.

In January, 1977, the members of our travel group attended the Maha Kumbha Mela, the largest gathering of people on the face of the Earth. Over thirty million people were there. On January 19, ten million people took a religious bath at the confluence of the Ganges, Jumna, and mythical Saraswati river.

Our group walked over long stretches of sand to the *sangam*, where the rivers meet. Although we walked several kilometers, we did not approach either end of the large gathering. Tent after tent filled all of those kilometers. Each tent was sponsored by a religious or spiritual organization. Gurus taught meditation. Some gave *darshan*, the blessing that flows from the mere sight of a saint. Some chanted songs to God. Many performed plays about the lives of the great saints and avatars.

\*Indian spellings may vary from source to source.

One large area, that of a well-known yogi, Kara Patri, contained within it a hundred sacrificial fires with Brahmin priests performing Vedic fire ceremonies with a large crowd of people circumambulating the area and praying. Another compound, dedicated to Paramahansa Yogananda, featured lectures on his teachings and devotional chanting by Brahmacharini Mirabai. She is considered to be one of the greatest devotional chanters in India. This was one of the few places where one could converse in English. In most of the compounds only Hindi or other Indian dialects were spoken.

As we walked on, the number of tents and compounds began to dwindle. We saw a large area where logs were being burned to warm *nagy sadhus*, devotees to Shiva, the god of the yogis. Their long, matted hair, never cut, trailed down their backs. They were clad only in ashes, in honor of Shiva, the sky-clad one, who owns everything and therefore possesses nothing. Most of these devotees carried iron tridents, a symbol of Shiva's power and completeness in the holy trinity.

We passed their camp and at the end of the island arrived at the holy bathing place. With some anxiety, because we had read of these boats turning over, a dozen of us crowded into a small boat. When the water came almost to the gunwales, our anxiety rose a bit more. Our boatman pulled us out into midstream, where the Ganges and the Jumna meet. He tied the boat to some large bamboo poles driven into the river bottom.

To encourage the others in our group, I wrapped a piece of cloth around myself

*The  
Rosicrucian  
Digest  
April  
1978*



**Bathing in the Ganges . . .**

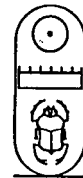
**On the occasion of a holy day, thousands of Hindus participate in spiritual ablutions in the Ganges. To many Hindus, this is a symbolic rite of lustration depicting purification of the mind.**

and took off my clothes. I could see the current was slow and the water looked about three meters deep. Clad only in a simple Indian dhoti, I jumped into the river. It was a shock. I thought I had broken both my knees. The river was less than a meter deep.

The others followed me, and we dipped and submerged ourselves for the prescribed three times. Natives around us were offering prayers to Shiva. We could not help feeling a certain amount of awe at this religious observation. It was obviously a special occasion for the Indian people to take this ritual bath, but once they had performed the proper number of dips they frolicked and played. There was no solemnity to the occasion, but rather a feeling of childlike joy.

I myself felt a sense of exhilaration that still comes back when I think of it. It was as if one's sins and ignorance were washed away by such a dip. I know that on my next trip to India, as soon as the Sun is rising, I am going to be in the river. While I am sure it will not mean the same to me as it does to a Hindu, nonetheless it makes one conscious and aware of the feeling of God.

In other parts of the world, when we go into a hallowed place there are hushed tones. An act of worship is a special thing, to be treated with reverence, to be talked about and experienced as special, and usually to be given a protected place among the experiences of daily life. In India, worship is as common as the daily bread; indeed, in many places, much



more common. Every bus driver or taxi driver has a picture of a teacher, guru, avatar, saint, or aspect of God in front of him. Every store has a small shrine on the wall. As one walks down the street he comes across small street shrines.

The members of our group were interested in every temple, every worship place that existed, and of course these places are everywhere. Every field has a small shrine, every hilltop a religious monument, and every village one or more temples, yet our guides passed them by virtually unseen because such places are so commonplace. However, the guides never failed to point out with great pride a factory that made tires, a manufacturing concern that fabricated steel, a new chemical plant, or other signs of industrial progress.

### *The Spiritual*

In India worship is not set apart but is an intimate part of everything that is occurring. Some of the people traveling with us could see nothing spiritual because they expected to find something happening in a secluded, walled-up place. As Carl Jung once commented about the philosopher's stone: *It is so hard to find but once it is found you see it everywhere.*

Because worship is everywhere in India, it is possible to miss it entirely. Perhaps that is the greatest paradox of India for someone from the West. One is so surrounded with the spiritual that he may not find it at all. To find it, one must look through unfamiliar eyes, at once impersonal and abstract, yet always intimately personal.

Most Westerners, when they worship, go into a quiet sanctum covered in brocade and filled with beautiful statues and pictures. If a traveler to India holds to this image he may see only the poverty, the lack of material wealth, and miss entirely the spiritual. Although one sees little shrines everywhere, most worship is private and in the home. Many people seldom, if ever, go to a large temple. The Western "Sunday worship service" does not exist in India. Every morning some worship is performed, a *pūja*—or perhaps serving God in animals, which occurs when the peasant wife gets up early and serves God through feeding the livestock. God can be an intimate part

of every aspect of everyday life and not something just put in a special, holy niche to be thought of at special times.

As we began to understand this attitude, we were not really surprised to find a naturalness and intimacy of worship at the fair. However, it was estimated that fewer than five thousand non-Hindu people attended last year. It is questionable how many understood the symbols of the ritual. I am sure that many of the Hindus did not.

The Ganges and Jumna rivers symbolize the two currents in the spine called *Ida* and *Pingala*. Their confluence or meeting place is the point between the eyebrows. The mythical Saraswati river represents the *Sushumna*, which is the spiritual current that flows in the center of the spine. When all three of these meet, the divine nectar of immortality (*amrit*) is produced.

By bathing at this point and at a time that is astrologically determined (in 1977 this was the most auspicious time astrologically in the last 144 years), one is symbolically uniting these currents and drinking the immortal nectar the yogis say is produced when these currents are united at the point between the eyebrows—the Christ Consciousness, or *Kutastha Chaitanya*, center.

On January 19, 1977, the most important day for bathing, it rained. Since it seldom rains at that time of year, the rain was considered to be especially propitious. It was said that heaven was cooperating by washing clean the very air.

*Kumbha Mela*, the name of the giant religious fair, comes from an old Hindu myth. At the beginning of creation the demons and the gods were fighting over the pot (*kumbha*) of immortality, and in doing so, twelve drops fell upon the Earth. One of these fell at the site of Allahabad, at the confluence of the Ganges and Jumna. There is no third river that one can see. The mythical Saraswati—the *Sushumna*—is very hard to find.

India is our opposite—very different from the West with its emphasis on material values. Yet opposites are tied together. They must have some dimension in common in order for them to be opposite. In the Western world we have emphasized control over the material

world, paying much less attention to the spiritual. In India spiritual development has been emphasized, with less attention paid to the need for material progress. The West has what India needs, and India has what the West needs. The

problem is how to bring these two together. If we study the symbolism behind India's spiritual fairs, we can learn to bring balance to the world of man and understanding in his search for the nectar of immortality. △

## 1977 Paris World Convention Souvenir Book

The Grand Lodge of France has prepared a special post-convention book consisting almost entirely of captioned color and black-and-white photographs of the Paris convention activities. There are many photographs of the worldwide Officers of AMORC, as well as the members, events, and special activities which made this convention so memorable.

The book, entitled **Convention Mondiale—Paris 1977**, is available only from the French Rosicrucian Supply Bureau. Cost of this limited quantity book, including shipping from France, is \$10.00 or 50 French Francs.

Please send your order and remittance directly to:

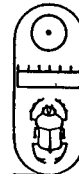
Les Editions Rosicruciennes  
56, Rue Gambetta  
94190 Villeneuve Saint Georges  
FRANCE

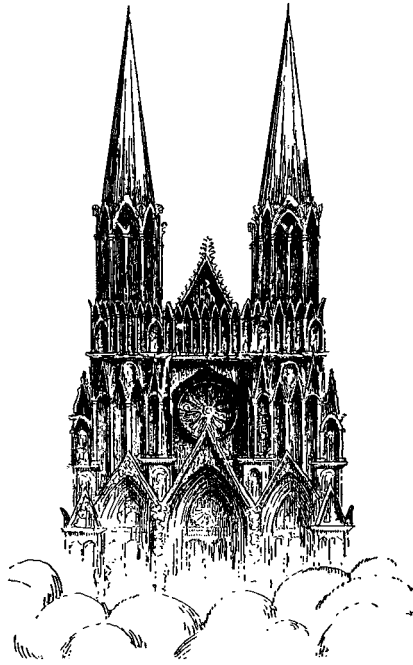
### YEAR-END STATISTICS

Members of AMORC are interested in the organization of which they are a part. Thus the statistics we offer here will be meaningful and helpful in bringing about a better understanding of the administrative functions of the Order:

Staff payroll .....	\$2,125,817
Total number of pieces of incoming mail .....	562,503
Total number of pieces of outgoing mail .....	2,905,331
Individually dictated correspondence .....	121,000
Payroll taxes and insurance .....	\$ 239,828
Property taxes, utilities, maintenance, and insurance .....	\$ 343,908
Printing costs (not including books) .....	\$ 786,392
Envelopes, office supplies, and stationery .....	\$ 177,042
Postage for the year .....	\$ 759,098

AMORC's financial records are audited by the internationally known auditing firm of Arthur Andersen & Company.





## The Celestial Sanctum

### The Mystical Life

by Robert E. Daniels, F. R. C.

**M**ANY TODAY are pondering on their future and the future of our society. Will peace and harmony prevail over the threats of war and strife? We who are on the mystical path know that the answer to this question lies in the hearts and minds of all individuals. Our leaders are striving for the peace we seek, but true peace lies within each of us. Only as we

*The  
Rosicrucian  
Digest  
April  
1978*

each strive for the harmony of our beings can true harmony come to the world in which we live.

The mystical life teaches man the qualities of tolerance, understanding, forgiveness, love, and compassion, as well as the ability to use his many God-given powers to make his life what he desires it to be. Through example and good deeds, through thoughtfulness and service, he encourages others to look forward to a better way of life.

A mystic is one who practices certain mystical principles. He is not a theorist or a dreamer. Like the doctor who practices medicine, or the artist who practices his art, the mystic practices certain things which mark him as being different in character from those around him.

#### *Qualities of Character*

There are qualities of character acquired by the mystic which are the result of his mystical training over a period of many years in which he establishes a relationship with the higher consciousness, or soul-life within him. This relationship brings a harmonious condition to his whole inner and outer consciousness which results in a uniqueness of character. He develops the ability to see things clearly and with a depth of understanding which is rare to find. He has a compassionate understanding of other people which draws and attracts those in need. His knowledge of life and of mundane things is more profound, revealing a deeper insight more comprehensive than others. He radiates love and sympathy and a warmth of personality revealing an inner strength. He is a talented person, with a love for the higher and finer things of life. He demonstrates a love of life and of all that is good and beautiful. He is not moody, petty, or concerned with trivialities. He abhors cruelty, waste, and all forms of evil and intolerance. He seeks truth and justice and to be in the service of his fellowman. And above all of this, he loves the God of his Heart.

The mystic is one whose whole life and training has prepared him for a special role in life, beyond the normal expected criterion of individual responsibility. He is sympathetically aligned to the heart of

humanity and places his life in service to his fellows from a level of special contact on the psychic plane with those who have a sincere need for the compassion and love of one who inwardly understands the needs of others.

In his vocational life, he is seen as one who gives more of himself in his work and, in his relationships, to those with whom he associates each day. His abilities are usually more developed than the average, but his cooperative outlook marks him as one who can be relied upon and trusted to a greater degree.

The mystic is one whose life is conditioned by an inward knowing and understanding of an inner truth. He looks at life with a higher sense of judgment. His insight into everyday affairs is conditioned by his relationship to the soul within him, which augments the everyday experiences acquired through study, education, and personal experience.

Today, the mystical life and all it has to offer is needed more than ever before. The lives of millions of people are so restricted and circumscribed by the material life in which they are engrossed that the inner self does not get a chance to express itself and live a normal and natural life. So many are conditioned by the circumstances of their environment, and all its depressing and painful experiences. The inner self cries out to be released from this bondage of material thinking. People require the inspiration and encouragement of those who tread the mystical path, who see things from a broader point of view, who can offer assistance, inspiration, and encouragement to lead a higher and better way of life. This is the role of the mystical student: to encourage others to follow his example, to be a beacon of light, in a sense, to those who are seeking to understand, to give life more meaning and greater value.

The mystical personality is greatly needed today in every walk of life. There is a growing need for a deepening concern about all aspects of life in the world in which we live. Never before have so

many been interested in the findings of psychical research; and although this research has uncovered much, what will be revealed during the next few years will prove to be more astounding than any discoveries of the past. What is needed, then, are persons whose understanding and whose own researches will be such that they can truly reveal and explain these new discoveries to the world at large. Without such explanations, there will be much confusion in the minds of many about these new discoveries in man's psychic world.

The world today, puzzled and confused as it is about many things, needs to see things from a more enlightened point of view. The facts, for instance, of reincarnation and Karma will change immensely the views and concerns of many people. They will come to know that life does not happen by chance, but that there is a universal law operating right through it. When they accept these principles and laws, life will take on a new meaning, and the spirit of man will see a new vision of the great possibilities lying before him.



### *The Celestial Sanctum*

*is a cosmic meeting place. It is the focal point of cosmic radiations of health, peace, happiness, and inner awakening. During every day, periods for special attunements are designated when cosmic benefits of a specific nature may be received. Nonmembers as well as Rosicrucian students may participate in the Celestial Sanctum Contacts. Liber 777, a booklet describing the Celestial Sanctum and its several periods, will be sent to nonmembers requesting it. Address Scribe S.P.C., Rosicrucian Park, San Jose, California 95191 stating that you are not a member of the Order and enclosing twenty-five cents to cover mailing.*



# The Destruction Of Two Ancient Libraries— Alexandrian and Mayan

---

by Joyce E. Pinter, F. R. C.

MODERN LIBRARY HISTORY, in a sense, begins with Aristotle, Alexander the Great, and the City of Alexandria, Egypt. The Alexandrian Library was the glory of the Greek world. Three calamities led to the depletion of its fine texts and to the ultimate destruction of the library's majestic walls.

Ptolemy Soter is credited with being the founder of the Alexandrian collection—used and appreciated by scholars and literary persons. Demetrius of Phaleron, an Athenian exile, became the first librarian. When Ptolemy II (often incorrectly called Philadelphus) succeeded his father, Demetrius was sent to distant lands in order to collect, by any means available, literary treasures. Money was spent freely, being no object in the acquisition of valuable manuscripts. At the time of Demetrius' death, over 400,000 rolls had been collected. The increase of Asiatic influence in the Greek world led scholars to build a comprehensive collection which some sources say amounted to almost one-half million rolls.<sup>1</sup> The library embraced almost the entire body of Greek verse and prose. Escaping the dangers of fire, flood, and war, the treasured books were safe until Julius Caesar arrived.

The first calamity occurred in approximately 48 B.C., when Julius Caesar landed at the port of Alexandria with his small force of 3200 legionnaires and 800 horses.<sup>2</sup> Assuming the role of tour guide,

Cleopatra impressed Caesar with the fabulous collections of learning. Seeing Caesar's enthusiasm and desire, Cleopatra offered many priceless books as gifts. Although he first refused the generous gifts, Caesar finally agreed. Great lamentations must have been emitted by the Keepers of the Books when orders were given for the packing of hundreds of items.

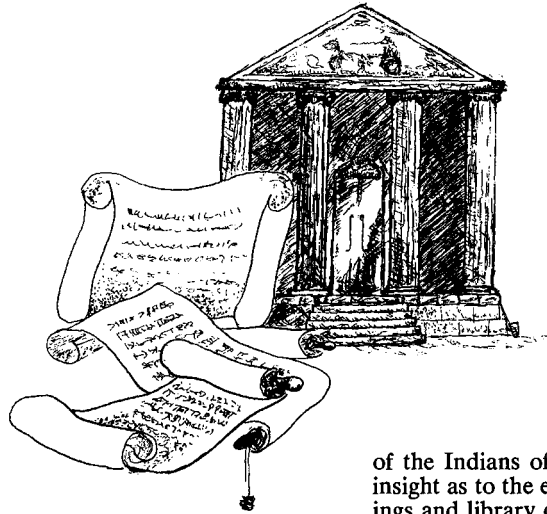
Stored in dock warehouses ready for shipment to Rome, these treasures became susceptible to a number of dangers. When threatening mobs attacked the palace, Caesar realized that his small company could not defeat the greater numbers of Egyptian foes. Since no other alternative would work, Caesar set fire to his own fleets. Although in military terms this plan was a success, the flames swept onto the wharves, and destroyed the warehouses housing the valuable manuscripts.

Original copies of Aeschylus, Sophocles, and Euripides, as well as the library of Aristotle, were housed in Alexandria. Large purchases of books were made in Athens and in Rhodes, the recognized centers of the book trade. Many years after Caesar's disastrous visit, Antony made good the loss when he presented to the Alexandrian Library the famous Library of the Attalids of Pergamum, numbering perhaps some 200,000 single scrolls. The total content of the library is speculative because no one will ever know the numbers, the authors, or the prices.

During the passing centuries, rulers and uprisings took their toll; but the Alexandrian Library itself seemed eternal

*The  
Rosicrucian  
Digest  
April  
1978*





and impregnable. Between A.D. 100 and 296, insurrections caused loss of volumes, but the library survived.

The second calamity occurred in A.D. 391 during the reign of the Christian emperor, Theodosius I. After the Church had triumphed, edicts went forth for the destruction of paganism. Frenzied mobs ransacked the Temple of Serapis which housed the Lesser Library and school. Only rubble was left of the interior of the temple.

The third calamity happened after the capture of Alexandria by the Moslem Arabs in A.D. 642, when Caliph Omar ordered the complete destruction of the Museum and Library. The 400,000 manuscripts which had survived the ravages of war, fire, and age were carried away in baskets to be fed to the fires that heated the baths of Alexandria. Having the same sentiments as the Christians, zealous Moslems believed that destroying the ancient temples and burning books was a step toward the establishment of a new religion.

#### **Mayan Libraries**

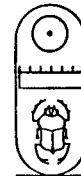
Libraries may have also existed in the Western Hemisphere. The Maya Indians of Central America may have stored much of their collected knowledge in libraries. However, literary sources covering information about archeological excavations, architecture, and civilization

of the Indians of Mesoamerica reveal no insight as to the existence of library buildings and library collections.

A hieroglyphic form of script or a compound system of ideographic and phonetic writing seems to have been used by the Maya. The bulk of these hieroglyphic texts occurs on stelae which are great monolithic monuments. Their prime purpose is uncertain, but these monuments often told of solar and lunar computations or had abbreviated inscriptions. Since many of the glyphs bear dates that fall on even, half, or quarter *katuns* (five years), the abbreviated inscriptions may have indicated time periods.<sup>4</sup>

Altars and lintels often contained representations of deities or ceremonies performed in their honor. Stories were set in the rear walls of temples. At Palenque a total of 620 glyph blocks yields the longest inscription still intact in the Maya area. Such writings are also found incised on jade, hard stones, bone, and shell; some are embossed on metal; while others are painted, carved, or molded on pottery.

Excavations of ruined cities reveal mostly tombs and temples. Civic structures were at a minimum. Religion played an important role not only in the Indians' lives but also in their edifices. In addition to the dominant temple pyramids of obvious religious use, most cities included a variety of additional structures whose precise use, except for the ball courts or gymnasium, can only be guessed. The names bestowed upon most ruins





were obtained either from legend or for the sake of convenience. *Could some of these structures have been libraries?*

A form of paper or bark cloth was used by the Maya. The Indians felted the bark of the *Ficus* into sheets by beating it with a ribbed mallet. Another method of obtaining paper was from the inner bast fibers of the wild fig trees.<sup>5</sup> Paper was probably used in Central America as early as 1000 B.C.<sup>6</sup>

The fact that the Indians had books and writing greatly astonished the conquistadors. In fact there may have been thousands of books. The greater part of the paper was used to keep native catechisms, almanacs, medical treatises, genealogies, and trial records.<sup>7</sup>

### **Three Codices Survive**

Only three Maya hieroglyphic codices have survived. Many were destroyed by order of the Roman Catholic Church because these writings were considered to be an integral part of the old Mayan paganism. The pious and zealous Bishop Diego de Landa and other monks burned twenty-seven hieroglyphic manuscripts at the famous *auto de fé* in Mani in 1562.

After Bishop de Landa's famous bonfire, the surviving manuscripts were kept concealed.

The three surviving Mayan codices are known by the names of the cities in which they now reside. *Codex Dresden* treats of astronomy and divination. *Codex Madrid* contains divination and ceremonies connected with various crafts and rituals of general importance. *Codex Paris* illustrates ceremonies and perhaps prophecies in connection with the endings of a sequence of times. None of the codices that spoke of Mayan history have survived.

After the Conquest, educated natives attempted to save something from the ancient cultural heritage by writing down in European script certain digests of chronicles. The ability of the Maya to write their own language in European script was due to the education policy of the Spanish missionaries. The Indians had great reverence for their hieroglyphic writing which was permeated with the symbols of their old religion. The friars felt if they could eradicate this knowledge and substitute in its place the European system of writing, it would be an effective means for the complete Christianization of the native population.<sup>8</sup>

As time passed, more European material was added to the native Mayan lore. Much of the history that society has today concerning the ancient civilizations is based on native accounts and on native literary material which was written after the Spanish priests came.

Future finds may give more light to Mayan legends, hieroglyphs, codices, and maybe even libraries. What man knows today is that books did exist. Surely those texts were stored in some manner. "Bernal Díaz saw piles of books near Vera Cruz: 'Then we came on some towns. . . [and] found idol houses . . . and many paper books doubled together in folds like Spanish cloth. . . ?'"<sup>9</sup> Since three manuscripts remain while reports of others still hidden beneath the ruins grow, surely in the future clues of lost libraries will be unearthed.

### **Footnotes:**

<sup>1</sup>De Vleeschauwer, H. J., "Les bibliothèques ptoléméennes d'Alexandrie," *Mousaion*, I, 1955, pp. 2-35.

(Footnotes continued overleaf)

<sup>2</sup>Parsons, Edward Alexander, *The Alexandrian Library, Glory of the Hellenic World*, The Elsevier Press, Amsterdam, The Netherlands, 1952, p. 286.

<sup>3</sup>Jacobs, Mendel, "Alexandria the Great," *Antiquarian Bookman*, Vol. 38, July 4-11, 1966, p. 42.

<sup>4</sup>Spinden, Herbert Joseph, *Maya Art and Civilization*, Falcon's Wing Press, Indian Hills, Colorado, 1957, p. 129.

<sup>5</sup>Von Hagen, Victor Wolfgang, *The Ancient Sun Kingdoms of the Americas*, The World Publishing Co., New York, 1961, p. 182.

<sup>6</sup>*Ibid.*, p. 183.

<sup>7</sup>Roys, Ralph L., *The Book of Chilam Balam of Chumayel*, University of Oklahoma Press, Norman, Oklahoma, 1967, p. 3.

<sup>8</sup>*Ibid.*, p. 4.

<sup>9</sup>Van Hagen, *op. cit.*, p. 183.

## CONSTITUTIONAL GUARANTEES

The Rosicrucian Order, AMORC, operates under constitutional rule. This assures each member certain rights and privileges in connection with his membership. We feel that every member should be aware of these rules as set forth in convenient booklet form. The twenty-ninth edition of the *Constitution and Statutes of the Grand Lodge of AMORC* is available for \$1.25\*. Order from the Rosicrucian Supply Bureau, San Jose, California 95191, U.S.A.

California residents, please  
add 6% sales tax

\*Other Currencies  
£.65 A\$1.13 NZ\$1.25  
¥4.83 €1.56 R1.08

## Medifocus

*Medifocus* is a special humanitarian monthly membership activity with which each Rosicrucian is acquainted. The significance of the personalities shown each month is explained to Rosicrucians as is the wording accompanying them. (The Rosicrucian Order, AMORC, is *not* a political organization. Our purpose in using metaphysical principles in *Medifocus* is to inspire moral judgment in the decisions which these leaders are called upon to make—more simply, to think unselfishly as humanitarians in the interest of the people whom they are leading and serving. Further, it is to help them to perceive clearly and to evaluate circumstances which arise so that their decisions are as free as possible from all extreme emotionalism and are formulated intelligently and justly.)

**May:** The personality for the month of May is King Hussein of Jordan.

The code word is **JOLE**.

The following advance date is given for the benefit of those members living outside the United States.



SPYROS KYPRIANOU

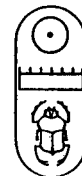
**July:**

Spyros Kyprianou, President, Cyprus, will be the personality for July.

The code word will be **MAAT**.



KING HUSSEIN





# MINDQUEST

REPORTS FROM THE RESEARCH  
DEPARTMENT OF ROSE-CROIX UNIVERSITY

---

## Magnetic Energy of the Brain

---

by  
**Michael Bukay, M.S.**  
Staff Research Scientist  
&  
**George F. Buletza, Ph.D., F.R.C.**  
Research Director

**I**N THE PAST ten years, significant advances made in techniques for studying biomagnetism have shed new light on our understanding of age-old Rosicrucian principles. As Rosicrucians we know that electric and magnetic fields direct and maintain the functioning of cells, tissues, organs, and even the brain. We know that an understanding of the principles of polarity and electromagnetism can greatly contribute to an appreciation of cell and mind activity.<sup>1</sup>

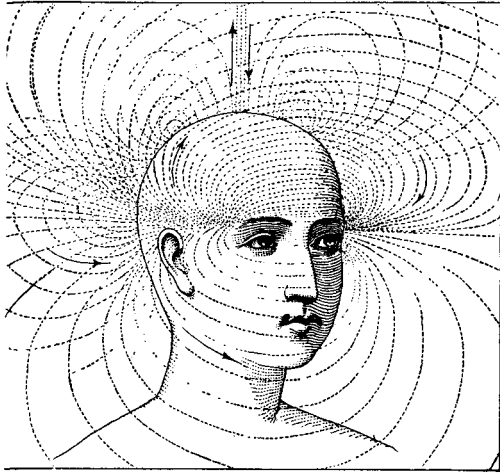
While we know that each cell of the body produces electromagnetic fields, cellular magnetic fields are so small in relation to the Earth's field and other background "noise" that cellular magnetism has been difficult to study. But fortunately, some groups of cells work together in synchrony and produce a com-

bined magnetic field. It is by studying these cell groups that major advances in biomagnetic research are being made.

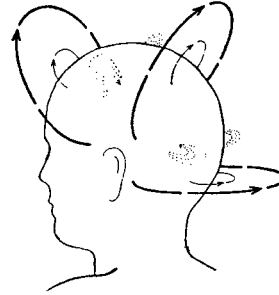
These rhythmical fields are found around the heart, brain, and other organs, but even as a combined field their strength is still extremely small. The instruments used to measure their activity must be capable of detecting magnetic field intensities only one millionth to one ten-billionth as strong as the Earth's own field. Therefore, scientific inquiry into biomagnetism had to await the development of supersensitive magnetometers, magnetic shielding, and filtering devices for reducing background noise.

The heart was the first human organ whose magnetic field was effectively studied. With an instrument called a magnetocardiograph (MCG), scientists were able to record rhythmical changes of the heart's magnetic field.<sup>2</sup> They discovered that the heart's magnetic field varies in parallel with its electrical field, and that both arise from the same source,<sup>3</sup> originating from the rhythmical flow of positive and negative charges in the nerve and muscle fibers of the heart. After these discoveries were made, attention turned to the brain.<sup>4</sup>

*The  
Rosicrucian  
Digest  
April  
1978*



**Figure 1:** Long before the development of instrumentation capable of measuring brain magnetism, Edwin Babblitt described magnetic currents passing around and through the brain. In the above diagram he depicted these currents as connecting both hemispheres in some places, and as rising and falling within each hemisphere. What is now emerging from modern research looks very much like what was imaginatively described by Babblitt a century ago.



**Figure 2:** General features of the brain's magnetic field as measured by a modern supersensitive magnetometer capable of detecting magnetic fields one ten-billionth the intensity of the Earth's own magnetic field. Modern descriptions of brain magnetism closely parallel those described by mystics over a century ago.

Over a century ago Rosicrucians and other mystics<sup>5</sup> described what appeared to be magnetic currents looping over the surface of the skull (see *Fig. 1*). What is now emerging from current research looks very much like what was imaginatively described by psychic attunement in previous centuries. *Figure 2* illustrates some general features of the magnetic field surrounding the head as measured by modern instrumentation.

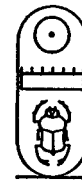
As in the heart, the brain's magnetic field was found to vary in parallel with its electrical activity. Bursts of alpha waves that appear when the eyes are closed are accompanied by bursts of magnetic activity.<sup>6</sup>

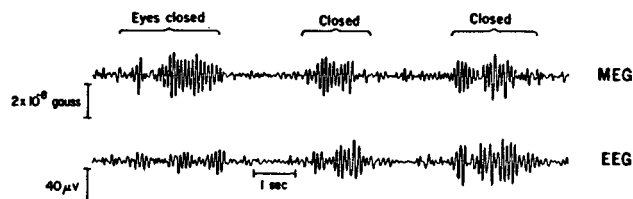
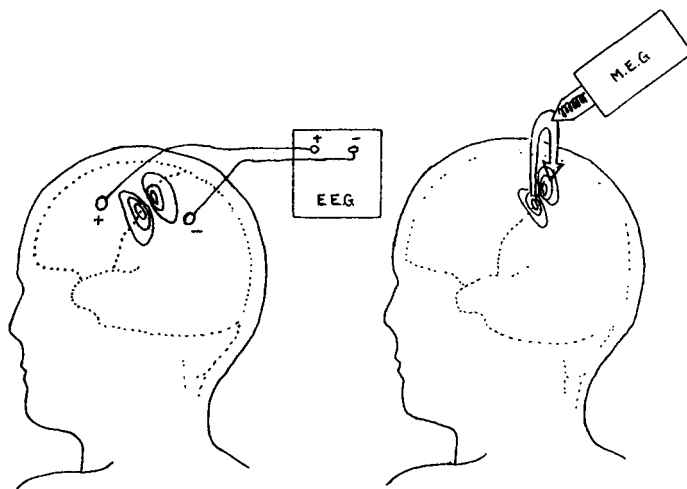
Information obtained from brain-wave studies with the electroencephalograph (EEG) is far from optimum. At present there is no simple and effective model that explains brain-wave phenomena.<sup>7</sup> With the EEG, electrodes must be at-

tached to the scalp, but because the skull is a poor conductor of electricity the pattern of electrical signals from the brain is distorted, making EEG recordings difficult to interpret. Distortion of the brain's magnetic field is not a problem, however, with the magnetoencephalograph—MEG (see *Figure 3*, page 20).

#### **Advantages of MEG**

The skull and surrounding tissues have little effect on the brain's magnetic field. The MEG does not require physical contact to make brain recordings and can therefore measure magnetic flux from a variety of positions around the head. Such measurements in the brain's three-dimensional magnetic field enable researchers to precisely chart areas of the brain that receive and integrate sensory information from specific body parts. States of consciousness may eventually





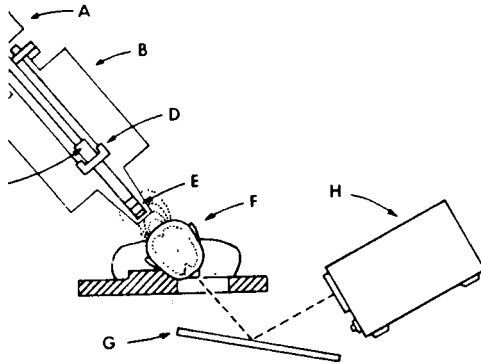
**Figure 3:** Magnetic fields are produced around the head in synchrony with alpha brain-wave rhythms. In this particular study, electrical and magnetic fields of the brain were simultaneously recorded while subjects opened and closed their eyes. Closing the eyes produced bursts of alpha brain waves. Opening the eyes blocked alpha. These changes in brain-wave activity (EEG) were accompanied by corresponding changes in the magnetic field (MEG) surrounding the head.

*The  
Rosicrucian  
Digest  
April  
1978*

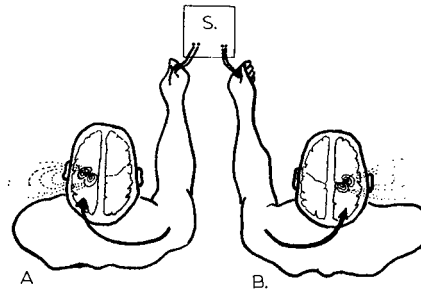
be found to have characteristic magnetic patterns around specific brain areas. Such measurements with the MEG will shed new light on our understanding of EEG brain-wave phenomena.

Since the magnetic field of the brain is about one ten-billionth the intensity of the Earth's own field, initial experiments with MEG instruments had to be performed in rooms with elaborate magnetic

shielding to reduce background magnetic interference. Recently, a more sophisticated MEG instrument has been developed which can measure the brain's magnetic field in a room without elaborate shielding. The instrument is called a SQUID (Superconducting Quantum Interference Device). The design of the SQUID and its experimental setup is illustrated in *Figure 4*.



**Figure 4:** The advent of the Superconducting Quantum Interference Device (SQUID) provides a field monitor of sufficient sensitivity to detect brain magnetic waves ( $10^{-8}$  to  $10^{-9}$  gauss) without special magnetic shielding of the subject. The SQUID is maintained at liquid helium temperature in a special glass container called a Dewar and is coupled to external fields by a loop of superconducting wire (a flux transformer) wound in the configuration of a second-order gradiometer. Arrangement shown is for monitoring visually evoked MEG responses: (A) SQUID electronics, (B) Dewar, (C) SQUID, (D) Trim Coils, (E) Gradiometer and pick-up coil, (F) Subject, (G) Mirror, and (H) Variable light stimulus for evoking brain response. After Brenner and Kaufman (1975).<sup>10</sup>



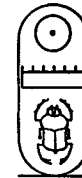
**Figure 5:** Pulses of direct current applied by a DC stimulator (S) to a finger of the right hand produced a magnetic field over a specific area in the left brain (A). Stimulation of a left finger produced a localized magnetic field in the right brain (B). The point source for these magnetic fields corresponds to the specific functional areas along the brain's Fissure of Rolando (see Fig. 6).

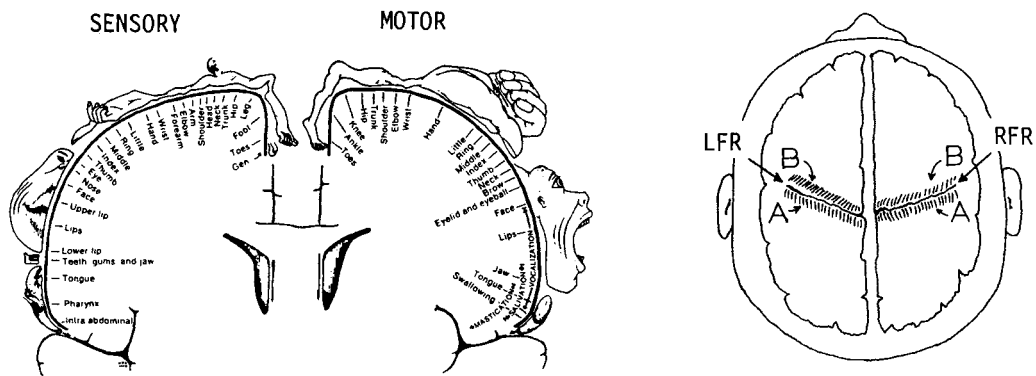
Brenner and his associates have used the SQUID to demonstrate that the electrical stimulation of the body produces a magnetic field from a specific area of the brain.<sup>8</sup> Pulses of direct current (1 milliamp D.C.) were applied to the subject's right little finger. Within 70 milliseconds, a magnetic field was detected around and over a specific area of the left brain responsible for the function of that finger (see Figure 5). Similarly, stimulation of the left little finger produced a magnetic field around the specific anatomical area of the right brain responsible for the left little finger function.<sup>9</sup> Stimulation of the thumbs shifted the magnetic activity by 2 cm, corresponding to the thumb's functional area in the brain (see Figure 6, page 22). The strength of the magnetic field increased as the frequency of electrical stimulation

increased from 3 to 30 pulses per second (see Figure 7, page 22). Visual stimulation also produced localized magnetic activity in the brain. Pulses of light directed into the eyes produced magnetic fields in the brain region specialized for processing visual information.<sup>10</sup>

These studies show that sensory stimulation affects the magnetic fields that surround the body. Even the thoughts we hold affect the body and its magnetic envelope. The magnetic aura changes with such moods as anger, depression, happiness, and Cosmic Attunement.<sup>11</sup> Preliminary experiments in the Rosicrucian Research Laboratories suggest that concentration on specific body parts (the Rosicrucian over-all exercise) may reverse the polarity of the magnetic inductive field surrounding each body part. These preliminary studies await verification by more vigorous studies made in magnetically shielded chambers or by means of such sophisticated magnetometers as the SQUID.

Magnetic fields are always accompanied by electric fields. Taken together they

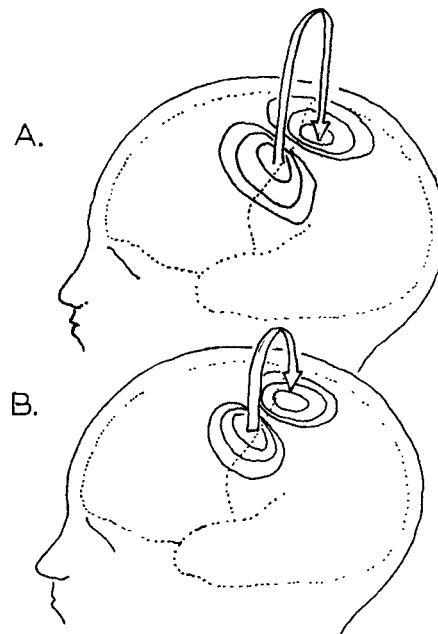




**Figure 6:** The homunculus shown above is a cartoon of the body showing the order of representation and the relative amount of space along the Fissure of Rolando that is devoted to each part of the body. Imagine the two sides of the brain sliced through the cerebral cortex along this central fissure. The sensory homunculus is arranged along the cortex to the back of this fissure (A). The motor homunculus depicting the body muscles is arranged along the cortex to the front of the fissure (B). The functional correlates arranged along the left Fissure of Rolando (LFR) directs the corresponding features on the right side of the body, while those arranged along the right Fissure of Rolando (RFR) direct the corresponding features on the left side of the body.

are called electromagnetism. Our body cells constantly emit and receive electromagnetic energy. Our brain generates an ever-changing electromagnetic aura that extends into the environment. Theoretically, these electromagnetic fields have no boundaries as they travel outward into an electromagnetic universe. We are electromagnetic beings living in a sea of electromagnetism.

Thus, all life on Earth is joined together by electromagnetic fields. We are in continuous contact with the electromagnetic auras of everyone around us. It may be that psychic attunement with another person or place involves a blend-



**Figure 7:** The frequency of sensory stimulation affects the magnetic fields that surround the head. A 30-Hertz (cycles per second) stimulus produced a large magnetic arc (A). A 3-Hz stimulus produced a small magnetic arc (B). This demonstrates that the strength of the localized magnetic field of the brain resulting from electrical stimulation of a finger increases in proportion to the frequency of stimulation.

*The  
Rosicrucian  
Digest  
April  
1978*





CHAPMAN

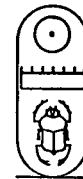
**Figure 8: Recent studies suggest that the subtle electric and magnetic fields in the environment affect our own electromagnetic field, our health, and our behavior.<sup>12</sup> In one experiment, activity rhythms of humans living in shielded chambers were shortened by exposure to electromagnetic fields. Rats exposed to a 60-Hz electromagnetic field for one month exhibited hormonal and biochemical changes similar to those caused by stress. As a result of these and other studies, the artificially induced EM fields from high-tension wires are being studied for possible adverse effects on human beings.**

ing of electromagnetic auras that triggers the appearance of symbolic impressions in the imagination. These psychic impressions are highly subjective. The symbolic details of form and color vary from individual to individual, but the meaning and interpretation of their subjective impressions are often quite similar. Subjective or inner impressions received through psychic attunement need to be verified by observation of the external world. Thus, future developments in magnetometer instrumentation may soon provide a new objective means of shedding light on the powers of our mind and imagination.

Footnotes:

- <sup>1</sup>Buletza, G. (1977) Your personal healing power, *Rosicrucian Digest*, LV(9):17; (1977) Secrets of the brain, *Rosicrucian Digest*, LV(10):18.
- <sup>2</sup>Baule, G. & McFee, R. (1963) *Ameri. Heart J.* 66:95; Baule G. (1965) *J. Appl. Phys.* 36:2066; (1965) *Trans. New York Acad. Sci.* 27:689.
- <sup>3</sup>Cohen, D. (1967) Magnetic fields around the torso: production by electrical activity of the human heart, *Science* 156 (3775):652.
- <sup>4</sup>Cohen, D. (1968) Magnetoencephalography: evidence of magnetic fields produced by alpha-rhythm currents, *Science* 161(3843):784.

(Footnotes continued overleaf)



(Footnotes continued from page 23)

<sup>5</sup>Babbitt, E. (1878) *The Principles of Light and Color*, Babbitt & Co., New York, p. 217-220; Von Reichenback, K., (1968) *The Odic Force*, University Books, New Jersey; (1974) *Researchers on the Vital Force*, University Books, New Jersey; Mesmer, F. (1779) *Mesmerism*, MacDonal, London.

<sup>6</sup>Cohen, D. (1972) Magnetoencephalography: detection of the brain's electrical activity with a superconducting magnetometer, *Science* 175(4022):664.

<sup>7</sup>Bukay, M. & Buletza, G. (1978) Electrical energy of the brain: a mind-mirror?, *Rosicrucian Digest* LV1(3):21.

<sup>8</sup>Brenner, D., Lipton, L., Kaufman, L. & Williamson, S. (1978) Somatically evoked magnetic fields of the human brain, *Science* 119(4324):81.

<sup>9</sup>Bukay, M., & Buletza, G. (1978) Split-brain research, *Rosicrucian Digest* LV1(1):14.

<sup>10</sup>Brenner, D., & Kaufman, L. (1975) Visually evoked magnetic fields of the human brain, *Science* 190(4213):480.

<sup>11</sup>Bigu, J. (1976) On the biophysical basis of the human "aura", *J. of Res. in Psi. Phenomena* 1(2):8.

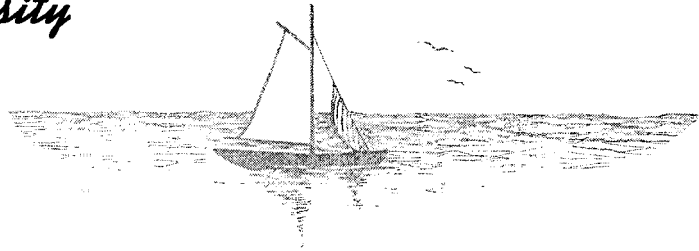
<sup>12</sup>Presman, A. (1970) *Electromagnetic Fields and Life*, Plenum Press, New York-London; Becker, R. & Marino, A. (1978) Electromagnetic pollution, *The Sciences* 18(1):14; Liboff, A. & Rinaldi, R. eds. (1974) Electrically mediated growth mechanisms in living systems, *Annals N. Y. Acad. Sci.* Vol. 238; Adey, W. & Bawin, S. (1977) Brain interactions with weak electric and magnetic fields, *Neurosciences Res. Prog. Bull.* 15(1).

### ROSICRUCIAN DIRECTORY

A complete directory of all chartered Rosicrucian Lodges, Chapters, and Pronaoi throughout the world appears in this publication semiannually—in *February* and in *August*.

## Rose-Croix University

Where Knowledge Is  
"Clear Sailing"



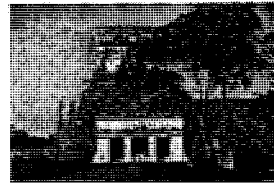
For a fresh vacation idea, consider one, two, or three weeks of study at R. C. U. To receive an application, fee schedule, and class descriptions, write to The Registrar, Rose-Croix University, Rosicrucian Park, San Jose, California 95191, U. S. A.

(R. C. U. June 19 - July 8, 1978. Students may register in person the first day of class. Advance registration deadline is June 1, 1978.)

The  
Rosicrucian  
Digest  
April  
1978

## Cover

Our cover this month features one of the many Mayan edifices located on Mexico's Yucatán Peninsula. This edifice is commonly referred to as the **Temple of the Jaguar**, because at its entrance is a recumbent stone statue of a jaguar. The jaguar was worshiped by the Maya.



(Photo by AMORC)

# Carl Jung

## and the Magicians' Fire

---

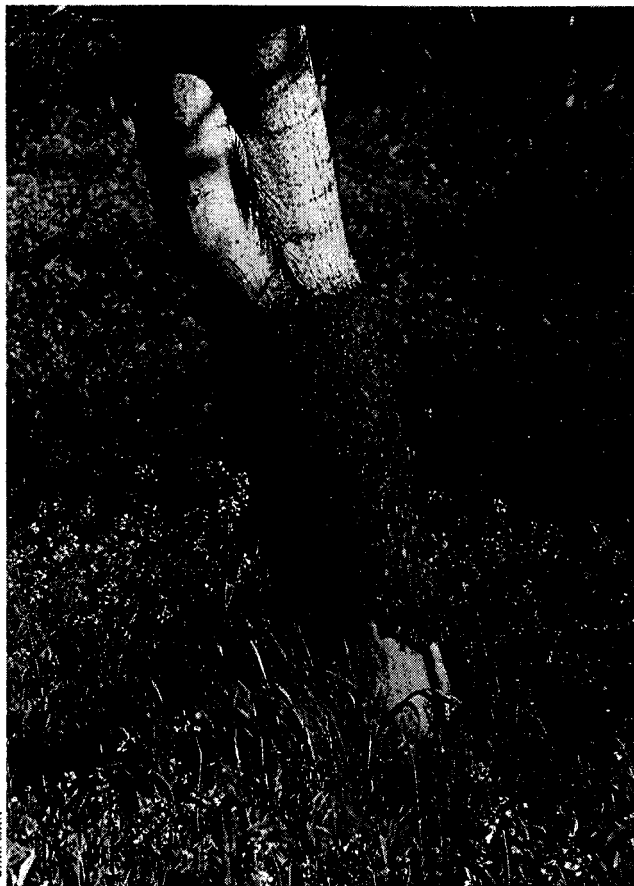
— by June Schaa, F. R. C. —

---

*"Homer, in the 8th book of the Iliad, speaks of a "golden chain" which connects heaven and earth; the golden chain of sympathy, the occult [hidden] all-pervading, all-uniting influence, called by him, such as Anima Mundi, Mercurius Philosophorum, Jacob's Ladder, the vital, magnetic series, the Magicians' Fire. . . ." —The Triangle\**

SUNLIGHT filtering through green leaves and a shadowy world of unanswerable questions threatened from childhood to split a wide-eyed boy named Carl Jung from the intense old man who was seeking his audience from within. From the age of seven to nine the young "heathen," as his folks would have dubbed him if his secrets were known, was fond of tending a "sacred fire" he built in a small cave in the garden wall. ". . . I performed the ritual just as I have seen it done by the natives of Africa; they act first and do not know what they are doing. Only long afterwards do they reflect on what they have done."<sup>1</sup>

A most profound incident in Carl's youth was the fascinating rumor that his grandfather, for whom he was named, was a natural son of Goethe. Although unsubstantiated, the story had an inner reality for Carl, and the opposing thoughts that Faust raised ate away at him with a secret inner fire. Just as Goethe's life had been obsessed with Faust, Carl felt a compulsion in his own life to discover the roots of personality. Therefore, he made up his youthful mind not to become a Babylonian and Egyptian archeologist,



\**The Triangle* was a former title for the *Rosicrucian Digest*. This quote is found on p. 34 of the October, 1923, issue.

to teach comparative religion, or paleontology—all of which he dearly loved. Instead, and as a compromise, Carl decided to devote his life to science, choosing to specialize in psychology, then an obscure part of medicine.

Religious concepts at first, and later the psychological concepts of Freud, left Jung wondering: "Yes, but there is something else, something very secret that people don't know about."<sup>2</sup> He had become convinced that there were psychic components which enter the individual psyche without apparent cause, unbidden. He was to propose that the psyche was dual: Not only does man have a personal unconscious, which could just as well be conscious, but also man "has" a collective unconscious which is autonomous.

#### A Discovery

In 1928, after having written his forward to *The Secret of the Golden Flower*—a book on Chinese alchemy—Jung stood at a crossroads. Two years later, and for the next ten years, Jung was to feel inwardly compelled to search for the traces of Western alchemy and disclose its meaning for him. But, having no Ariadne to provide a string, Jung wandered in a labyrinth of obscure texts and meaningless words until at last he found in the 16th-century *Rosarium Philosophorum* a pattern enabling him to begin a lexicon of key phrases—leading him, like all philologists, to unlock the door leading to the *symbolic* language of the medieval alchemists. "The experiences of the alchemists were, in a sense, my experiences, and their world was my world," he said.<sup>3</sup> Following this, Jung was able to uncover an uninterrupted intellectual chain going back to Gnosticism. A momentous discovery! He had unexpectedly stumbled on the historical counterpart of his psychology of the unconscious.

In his seventies Carl Jung, creator-scholar, chopped wood to feed the fires within his round hand-built stone tower at the edge of a quiet forest lake. The many symbols here at Bollingen seem to answer that karmic urgency, although Jung did not believe in reincarnation. And the mystery deepens as we read above the tower gate: *Shrine of Phile-*



Carl Jung's Coat of Arms

(ILLUSTRATION: RICHARD MAJKA)

*mon—Repentance of Faust.* Repent what we may ask? A voice cuts through the wood-smoke: "[In my youth] the dichotomy of Faust-Mephistopheles came together within myself into a single person and I was that person." Later he linked his work to what ". . . Faust had passed over: respect for the eternal rights of man, recognition of 'the ancient,' and the continuity of cultural and intellectual history."<sup>4</sup>

In our mind's eye we see the gate open. Before us stands an agile, typical Swiss peasant, a veritable magician with chisel in hand, dressed in a workman's apron. The answering words had come from a cultured Professor Jung, the bosom friend of 'the ancient,' Philemon, who was his "second personality."<sup>5</sup>

Invited within, we are soon intrigued by Professor Jung's family coat of arms which he had painted upon the ceiling of

*The  
Rosicrucian  
Digest  
April  
1978*

his tower. Observing our interest, he informs us that the Jung family originally had a phoenix bird for its arms, but that his grandfather for whom he was named had changed the elements to perhaps reflect his own ardent philosophy. Jung's coat of arms are still in keeping with this revision of his grandsire, containing a blue cross in the upper right and blue grapes in the lower left in a field of gold; separating these is a blue bar with a gold star—a pentagram. Professor Jung continues: "The symbolism of these arms is Masonic, or Rosicrucian. Just as cross and rose represent the Rosicrucian problem of opposites (*'per crucem ad rosam'*), that is, the Christian and Dionysian elements, so cross and grapes are symbols of the heavenly and chthonic spirit. The uniting symbol is the gold star, the *aurum philosophorum*. . . ."<sup>8</sup>

Professor Jung contended that the Rosicrucians derived from Hermetic or alchemical philosophy. "One of their founders was Michael Maier (1568-1622), a well-known alchemist and younger contemporary of the relatively unknown . . . Gerardus Dorneus. . . ."<sup>7</sup> Both Maier and Dorneus, who wrote so ably on the *process of individuation*,<sup>8</sup> were fellow citizens with Professor Jung's ancestor, another physician and jurist named Carl Jung, who died in 1654. It is safe to assume, Jung assures us, that this ancestor was influenced greatly by the alchemical philosophy then flourishing in Frankfurt. Jung felt that this ancestral connection was equally as interesting as the legendary connection to Goethe!<sup>9</sup>

Faust confessed: "Two souls, alas, are housed within my breast," but he did

not disclose the cause of this dichotomy. Eventually, Jung was to reflect that it seemed to him the fateful links binding him to his ancestors were his own deeply personal reactions to what was really a collective problem faced alike and anew by every person who becomes deeply introspective. However, he adds, "The less we understand of what our fathers and forefathers sought, the less we understand ourselves, and thus we help with all our might to rob the individual of his roots and his guiding instincts, so that he becomes a particle in the mass, ruled only by what Nietzsche called the spirit of gravity."<sup>10</sup>

It is time for us to begin building our own "circular towers" where we might atone to the *Great Man* dwelling within us all, and live "simultaneously with the centuries." Only then shall we really know, with Jung, that "Called or uncalled, God is present,"<sup>11</sup> mortal for everyone but untouched by the cycle of eons: an orphan found everywhere, at once youth and old man; the golden chain and the magicians' fire within our innermost soul.

Footnotes:

<sup>1</sup>Jung, C. G., *Memories, Dreams, Reflections*, University Press, New York, 1963, p. 23.

<sup>2</sup>*Ibid.*, p. 22

<sup>3</sup>*Ibid.*, p. 197, p. 205

<sup>4</sup>*Ibid.*, p. 235.

<sup>5</sup>*Ibid.*, p. 225.

<sup>6</sup>*Ibid.*, p. 232

<sup>7</sup>*Ibid.*, p. 233

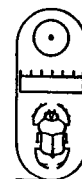
<sup>8</sup>*Ibid.*, p. 209

<sup>9</sup>*Ibid.*, p. 35, p. 233

<sup>10</sup>*Ibid.*, p. 236

<sup>11</sup>The Delphic motto carved in Latin over Jung's door at Küsnacht, Zurich.

**Next Month** — *Rosicrucian Digest's Odyssey* column (outside back cover) begins a three-part series on Carl G. Jung—innovative psychologist, artist, and independent thinker. *Odyssey* explores the lives of men and women who have searched for light and understanding, making valuable contributions to the material and spiritual evolution of man.



# Going Back?

## Where You've Been

## Affects Where You're Going

---

by Bruce Roberts, F. R. C.

IT IS the tendency or natural innate urge in man to *go forward* and progress in life. Of course, this is altogether fitting and proper; it is the goal of each individual to advance or evolve his being. How, then, can *going back* help us in our quest to attain advancement? Let us start with some very basic examples and proceed from there.

It is the normal tendency for most of us to discuss the events of the day with our friends or family when we come home from work or other activities of the day. When we awake in the morning, we review and evaluate the sleep and rest we received the night before. We are not always aware of the fact that we are doing this, but all of us do this, and it reveals itself in our actions and attitude of the day.

Even the simple act of checking the time of day is an example of going back, and in this example we can find the purpose of doing so. Why do we bother to check the time of day? Is it not often for the purpose of evaluating what we are presently doing, comparing our accomplishments with the time that has passed, and preparing or planning the remainder of the day?

For example, arriving at work at 8:00 a.m., we begin to perform our daily tasks. We have certain matters which should be attended to first and others

that come as the day progresses. By going back and checking the time at 11:40 a.m., we could quickly rehash what we had accomplished thus far, realizing that we should not get involved in a work project that would require two hours of our attention, for example, if lunch time is at 12:00 noon. Rather, we should use our remaining twenty minutes to attend to smaller projects and then start the two-hour job after our lunch.

Simply stated, *going back* makes us aware of where we are at present, where we have been, and how to proceed to where we are going. Going back helps us plan and give direction to our life. This reminds me of a very wealthy businessman I once knew who was constantly pursued for his formula of success. He told me the first thing a person had to know: "You have to know where you are at, where you've been, and where you want to go." He further related that most people would spend more time planning a two-week vacation than they would care to spend planning their very own life!

### *Applying Mysticism*

After some thought, most persons will concede that the above examples are true, although most individuals have never taken the time to look at the matter in such a way. Let us now take a broader look at going back and discuss different methods and their advantages to our lives.

The science, study, and practice of mysticism affords each individual student the opportunity of developing this art of

*going back.* In mysticism this is referred to as reflection. This probably comes closer to home for most of us, and we are beginning to feel more comfortable with going back—if we refer to it as reflection. What is reflection? It is the bending of light until it shows the source of its emanation. Early in our studies we begin with the practice of daily reflection upon our acts of the day. We give thanks to the Cosmic for our good actions and ask for direction in correcting our errors. If we are sincere and properly motivated, we find that this practice soon becomes one of our most valuable methods for overcoming the obstacles in our life by helping us to realize what we must create in order to achieve more harmonious conditions in our life.

In realizing the truth and practical benefits of this principle, many ask: "How far back should one go?" Along with this we also hear the same question: "How far *can* one go?" It is my opinion that it is possible to go back through all time and space to the beginning point of the realization of consciousness. Beyond the beginning point of consciousness there would be nowhere for one to go for there would be no awareness of Self or even soul personality. The beginning point, however, might be a form which some experience as Cosmic Consciousness. Although beyond this there would be no psychic awareness of sound, sight, odor, color, or feeling, in going back to this fine point of the realization the only thing one could possibly realize would be a sense of vibratory Being or Existence in this sea of all that is.

We also know that it is possible for some people to experience past lives. This, of course, deals with reincarnation which is not the main objective of this discussion. It is well to remember in this discussion, however, that going into past lives is primarily for the purpose of realizing our mistakes and then striving to perfect our shortcomings on the earth plane during the present incarnation.

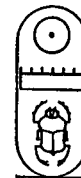
We now come to the question which is eventually asked about all the laws and principles of the universe: "How does one know?" It is not my purpose to try to avoid this question or I would not have mentioned it. As in all experiences, however, whether they be mystical, psy-



chic, or objective, our experiences are personal and so is our interpretation of them. Only you can know for yourself and only you can know *how* you know!

Let us recall the first part of our discussion, pertaining to how we go back over the events of the day with our family and friends. How did you know what to say to them? You knew because you were the one who had those experiences. Someone else may tell your friends what you did on any given day, and they may express it truthfully and to the best of their ability. However, they could never tell it exactly the way you experienced it. Truthfully, you cannot relate the same experience, but you can give the best account because you are the only one who experienced what happened to you and *you know*.

For those who are interested, and may have had some deep experiences in going back, let us mention some of the phenomena you may experience or expect in connection with this principle. For purposes of practicality and time saving, in this discussion we will deal only with events of the present lifetime. You may



notice at a point in life that you begin to have dreams of seeing old friends or old places that you have known before. Some may be very important to you. Others may be people or places of whom you would not normally think, much less dream. Strangely, these events can be recalled in perfect detail such as the lines on the faces of people, the exact color of eyes that only *that* person had, or other characteristics of persons and places that you never consciously realized or noticed before.

There was once a man who revealed information to me that indicated this experience almost perfectly. He related that sometime during the past four or five years, following several years of study of mysticism, he had started to dream of old high-school friends. Some, he stated, were close friends; others were just acquaintances. Some were people he just passed along the hallways every day. These events continued, and he said that the experience began to feel like an out-of-the-body experience. It was so real he thought it had to be a dream. Can you imagine that? At the same time, he related, he also felt that this experience was a projection. He began to experience seeing all kinds of people, places, and things that he knew he had experienced somewhere before in his life. No conversations were ever held with these people. He found no purpose in visiting the places—although I may add, the purpose often revealed itself at a later time. All of this amazed the man, and he

enjoyed the experiences very much. He further related that a particular experience really made him start thinking.

One night, after retiring, he was in a borderline state. He went back to the large two-story, twelve-room house where he had lived when he was seven years old. He experienced going through every inch of that house like a man who is given all the time he needs to find rare and priceless jewels. He saw the cracks in the walls, the doorknobs on the doors, the chipped paint on the ceiling, the handles on water faucets, the rust on pipes under the sinks, as well as numerous other small details. The picture experienced was very clear and vivid, and he said that if someone had previously offered him the riches of the world to describe this home in his objective state, he could never have remembered these things.

Nor is this the strangest part. The man said he had personally visited the site of that house more than seven years earlier. The house had been torn down—it no longer existed at the time of his experience.

Time and space? The Akashic Records? Everything that ever was or will be is here in potentiality. However, as individuals we must learn to create and align ourselves with harmonious conditions and work out our own mastery of life. This we can do by learning to redirect our energies through working with the principle of *going back* into the past, which then becomes our now. Coming back to the present will then make a better future. △

#### ROSICRUCIAN CONCLAVES

DELAWARE, WILMINGTON—Middle Atlantic Regional Conclave—May 6-7, Sheraton Brandywine Inn, 4727 Concord Pike, Wilmington. Grand Lodge will be represented by Frater Edward L. Fisher, Grand Treasurer of AMORC. For more information, please contact Donna M. Dercole, Conclave Secretary, 2412 Ivanhoe Lane, Wilmington, DE 19808.

FLORIDA, MIAMI—AMORC Southeastern Conclave—May 11-13, Deauville Hotel, 6701 Collins Ave., Miami Beach. Grand Lodge will be represented by Frater Edward L. Fisher, Grand Treasurer of AMORC. For more information, please contact J. E. Nichols, Conclave Secretary, P.O. Box 660723, Miami, FL 33166.

OHIO, YOUNGSTOWN—Sixth Penn-Ohio Regional Conclave—May 19-21, Holiday Inn, 1620 Motor Inn Drive, Youngstown. Grand Lodge will be represented by Frater Edward L. Fisher, Grand Treasurer of AMORC. For more information, please contact Mr. and Mrs. Walter A. Young, Conclave Chairman and Secretary, 233 Crandall Ave., Youngstown, OH 44504.



by Dr. H. Spencer Lewis, F. R. C.

# The Mystical Arts



---

*This article, by former Emperor Dr. H. Spencer Lewis, was recently found among several old manuscripts. It has never before been published.*

---

THE STUDENT who delves into the subject of the fine arts and reviews the history of present-day art forms, tracing them to their earliest origin, soon discovers that all arts had their beginning in man's attempt to apply in a practical way mystic principles as he comprehended them.

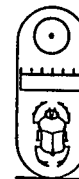
Today we classify most of these arts as the "fine arts," but it is difficult to separate them from the mystical arts. In early days these fine arts appeased the soul, gave joy to the eye and heart, and symbolized man's thinking and forms of worship. Today the fine arts not only supply this necessity, but contribute to the practical needs of civilization. In the same way we have music which is not only meat to the soul, but has an important effect on the health and upon the mental disposition of individuals. Painting has revealed the significance of colors and their effects upon the physical organization of man.

Tracing the fine arts from their earliest forms of development, we must not lose the thread of the mystical side of their nature and purpose. We should never study them for their intellectual value only. If our studies are to broaden our viewpoint, then we are warranted in giving them all the time possible.

It would seem from all the evidence that man's first analysis of himself and his surroundings affected his emotions and attuned him with something higher and better than himself. All in all, we have a magnificent picture of the fact that man was inspired in his earliest reasoning as he is today and that there is such a thing as *divine revelation*.

Primitive man began to make his images of God out of stone or other material. He believed that the image would help him to concentrate his mind, or act as an intermediary connection between him and the invisible God. It afforded him a place to go to pray. The image provided a definite point for beginning his prayers. It enabled him to consecrate a place, and to create a sacred environment for his religious or philosophical thinking. In making these images there suddenly came into existence the development of the fine arts and the sciences.

Primitive man laid the foundation for many of our present-day arts and sciences, for all of our human employments



and conceptions. He was guided in all of these things by unwritten laws and principles which he hardly realized.

It proves that man has within him a creative power that can be guided and directed by cosmic inspiration if he will attune himself and permit himself to be directed by it.

Primitive man had the advantage of never having had advisers or any other form of influence to tell him that he was wrong, or that he should do otherwise than what he felt he should do. Therefore, he had to use individual choice. He had to choose between the impulses, the impressions, the ideas that came to him from both his own worldly mind and from the Cosmic. He chose to listen to the latter, and therefore was guided aright.

#### ***Lost Knowledge***

It is easy to understand that in the centuries that passed between the time when early man began to think independently, and the much later time when man began to have original thought not influenced by books or schools, many superstitious beliefs developed. Many of the advances in the fine arts were forgotten in the rush for new ideas, or in the insistence upon the development and acceptance of certain dogmatic creeds and forms of teaching. In this way much of the ancient wisdom possessed by the Egyptians, the East Indians, and peoples from other countries became lost, buried, or set aside, and man entered a period of darkness which threatened to take away from him knowledge discovered and taught in the preceding centuries.

More significant structures throughout the world have been conceived and designed by persons inspired during an emotional period than were ever designed

by men working along materialistic lines, and the same is true of art and of music.

For this reason it behooves the student of the subject of mystic arts to investigate and analyze the effect and influence of the human emotions upon the development of the fine arts today. Through studying and analyzing human emotions, the things which affect them, as well as the things created by them, we come to have a better understanding of man, his relationship to others, and his relationship to God. That is what we have to do whether we want to become workers in all fields of human effort, or apply ourselves specifically to some one phase.

It is true that many of the mystical features and elements of life are still sublime mysteries, but it is not true that all of the mysteries of life are mystical in nature. The mystic's viewpoint is broad in this regard; he considers many things divine which the average person labels natural—for instance, the rays of light and energy radiating from the Sun.

Applying such ideas to present studies, we shall find much that we call *mystical* in those arts and sciences taught in our Rose-Croix University. \*

The art of mixing colors and of producing certain psychological effects through their combination is still a mystical art even though science recognizes that scientific principles are involved. Mystical arts and mystical elements in life are like pieces of a puzzle picture—of different shapes and colors and so disconnected that we cannot see the relationship of one piece to another until we start to put them together.

\*For more information about courses offered in the summer session of *Rose-Croix University*, please write to the Registrar, Rose-Croix University, Rosicrucian Order (AMORC), San Jose, CA 95191, U.S.A.

***The  
Rosicrucian  
Digest  
April  
1978***

***"There is no excellent beauty  
that hath not some strangeness  
in the proportion."***

***—Of Beauty  
Francis Bacon***

# **Don't Despair!**

## **A Mystical Approach for Overcoming Depression**

---

by Walter J. Albersheim,  
Sc.D., F. R. C.

**D**EPRESSION, a heavy affliction of the spirit, is known all over the world, to mystics and non-mystics alike. The ancient Greeks called it "melancholy" (black bile), hinting at a chemical, material cause. But depression is primarily a mental condition hitting people of good outward health as often as those who are ill or invalid.

We are all familiar with the symptoms of depression: boredom, lassitude, sadness, and an inability to make decisions. We may know or we have been told that strenuous activity is the best remedy, but in the depressed state one may not be able to muster the will and the effort required. Nothing seems worthwhile. In a healthy state or mood we view the world as presenting us with a mixture of good and evil, of pleasure and pain, of right and wrong circumstances. But when one is depressed, he is apt to see only the wrong, only the evil, only suffering. Worse yet, the world seems devoid of any sense and meaning.

This state of mind has little to do with faith or with the lack of faith. To the atheist, this old world that has so slowly and painfully evolved from amoeba to man, seems headed for imminent chaos and destruction. The believer, on the other hand, feels that God has forsaken him. Which is worse?—To see no sense, no meaning, no direction in the world, or to believe that the Divine Ruler of the universe has rejected us as unworthy of His Grace?

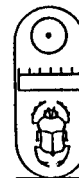
One might think that a true mystic is immune to such fears of abandonment because he sees God in the entire universe, including himself. How could God reject the soul that is part of Him? Just the same, even the most aspiring mystics know only too well the "dark night of the soul"—bringing them to the brink of despair. There is a difference, however. The non-mystic may succumb to the insidious temptations of despondency and escape into cynicism, insanity, or even suicide. The mystic, on the other hand, usually passes this severest of tests and emerges triumphantly from black gloom into the golden dawn of the soul and finally into the dazzling light of illumination. The reason for this "break-through" may be that even in the throes of despondency, the mystic maintains his own love for the God of his heart and his fellow creatures. He may at times feel worthless, but not alone.

When facing depression, what can you and I do to be healed, or to heal ourselves? The description of the individual symptoms points to remedies. If there be a chemical cause, try a change of diet; if no food tastes right, try plain water. If beset by lassitude, try a walk in rain and storm.

### **Helping Others**

If one is immersed in self-pity, perhaps that person should go to those who are worse off than themselves. One might read to a blind student, shop for a lame housewife, or baby-sit for a young mother, providing her with an opportunity for some personal shopping or visiting.

However, a reader might add: "You talk of outward symptoms and super-



ficial remedies, but you haven't touched the underlying condition, the affliction of our innermost consciousness!"

Where is the seat of our individual suffering? As Rosicrucians we cannot call it a sickness of the Soul, because Rosicrucians hold that the Soul is perfect, unchangeable, an unseparated part or manifestation of God—the Cosmic. In the triune junction of body, mind, and soul, the sufferer is the intellect—the bridge between body and soul. Our mind suffers from awareness of our own imperfections, but even more from those of the physical world in which we live.

This world is broken into a myriad of individual living beings—all of them, like ourselves, subject to the alternation between fleeting joys and pain. We are all born and must suffer death, devoured by inner decay or by outward predators. Our intellect cries out: "What is the use of enjoying food, love, beauty, or learning, if all our accumulated physical and mental treasures must be surrendered at death?" This, I believe, is the underlying reason for our despair, for occasional disgust with life itself, for our depressions.

#### *Help From Within*

If there is a help, a release from this *Weltschmerz*, this basic despondency, it must come from within, from our own soul personality. No matter how we scoff at it, shrink from it, deny it, we must face up to the fact that each one of us is part of an eternal Soul manifesting through an imperfect, though growing, personality housed within a mortal body. Many individuals can face this only in their more strange dreams and must consult a psychiatrist to have such dreams interpreted. Others become conscious of it either through religious faith or through instructions from a personal teacher or from a school of mysticism. The faithful resort to prayer, mystics to meditation.

In meditation, sitting relaxed but preferably upright to keep from becoming drowsy, we can calm our jittery nerves

and analyze our own depression. If our depression of the moment is based on a specific misfortune of our own or of our loved ones, we might visualize, and thus mentally create, an alleviation of the problem.

There is a basic difference between prayer and mystical meditation. The believer prays to a God outside and above himself for help. The mystic, who is confident that his own soul is divine, musters his own inner strength to create the desired condition.

But this inner work is only part of the healing. First, it is obvious that one cannot remedy all misfortunes of the personal self, much less those of the outside world. An individual's own condition, his *karma*, may be the logical consequence of earlier errors of thought and deed, as well as those of others with whom the individual is closely involved. As to the situation of our own family, our group, our city, nation, and of mankind and the world at large, it is obvious that the collective thoughts and actions of our fellow beings may outweigh our most strenuous personal efforts.

Secondly, even the collective thinking of all mankind cannot eliminate suffering and death. These are inherent in a material, ever-changing world; a truth that has been taught by most religions, especially Buddhism and Christianity.

Suffering must be accepted and then overcome through a process of rising to the transpersonal, cosmic level—the state that Spinoza referred to as "the aspect of eternity." God Himself, whose body is this material universe, feels all its suffering but accepts it for the sake of its greater and lasting joy. We can do the same to the degree of our oneness with Him. This is the true and only way to overcome depression. It is not an easy process and is not attainable at all times. Nor is it attainable *forever*, as long as we are in this fallible world.

Overcoming depression is worth all the effort and pain to those who have attained it. It is this achievement that brings—if only for one fleeting instant—what mystics called "Peace Profound." △

---

# Rosicrucian Activities

## Around the World

---

A RECENT RECIPIENT of the Rosicrucian Humanitarian Award was Mr. Leo P. Lemieux, founder and President of the Blackstone Valley Association of the Blind, Woonsocket, Rhode Island. Blind since 1969, Mr. Lemieux has successfully fought the image that handicapped people are "helpless." He devotes much of his time to working with handicapped and elderly persons. Mr. Lemieux is an active lobbyist in his community for traffic safety devices, such as ringing signals, which help make dangerous street corners and intersections more safe for blind pedestrians. He has also worked successfully for the installation of ramps in public buildings—making these buildings more accessible to handicapped people. Most recently Mr. Lemieux has been a prime mover in the creation of a recreation center for handicapped individuals. The new center, opening last year on a once-a-week basis and serving ten people, has now expanded into neighboring communities and will serve 500 people on a five-days-a-week basis.

The Rosicrucian Humanitarian Award was presented to Mr. Lemieux by members of Roger Williams Chapter, AMORC, at a dinner honoring the recipient. In attendance were city dignitaries, members of the press, Rosicrucians, and members of the Blackstone Valley Association of the Blind.

---

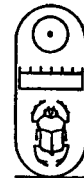
In January, members of the Phoenix Chapter, AMORC, held their annual workshop—and it proved to be a most successful venture. The Guest of Honor for the occasion was Grand Master Robert E. Daniels. The workshop pro-



*For his work with handicapped people, Mr. Leo P. Lemieux (right) is presented the Rosicrucian Humanitarian Award by Mayor Gerard J. Bouley (left), and Frater Lawrence J. Keefe of Roger Williams Chapter, AMORC.*

---

vided the opportunity for Rosicrucians in the Phoenix area to enjoy a program especially prepared to enable them to express themselves, and it provided the Grand Master with the opportunity of meeting with local members and discussing Chapter activities. Early in February, Grand Master Daniels performed a Dedication Ceremony for the Diana Chapter, AMORC, in Salt Lake City, Utah. A large number of Rosicrucians from the area participated in the ceremony—also enjoying the opportunity of meeting with the Grand Master. While in Salt Lake City, Frater Daniels also spoke to a large audience of non-members at an AMORC public meeting.





## *Is Man Subject to Solar Cycles?*

DOES light exert a *strange influence* on man's mind? Are wars and large-scale political upheavals the result of subtle cosmic disturbances? Sun spots alter your radio reception—do they also produce aggravating effects upon your nervous system? You are being continually bombarded by invisible radiations from space. Learn about these mysterious energies and how they influence your thoughts and moods.

### **Free Manuscript**

Merely subscribe or renew your subscription to the *Rosicrucian Digest* for one year—and ask for the *free* manuscript entitled "The Influence of the Sun on Human Affairs."\*\* \$7.00\*\* for each one-year subscription.

**The ROSICRUCIAN DIGEST**  
San Jose, California 95191, U.S.A.

\*This offer does not apply to members of AMORC, who already receive the *Rosicrucian Digest* as part of their membership.

\*\*Other Currencies  
£4.40 A\$7.00 NZ\$7.00  
¥4.65 €8.75 R6.10

### **THE HISTORICAL SEINE RIVER**

The Seine River is the third largest river in France, but the most important economically. It is shown here flowing through the heart of Paris. The Seine is symbolically a ribbon that ties fast great events in the history of France as it flows past edifices, statues, and sites where momentous events occurred. The several old bridges which cross the Seine in Paris are not only picturesque but are related to tragic and romantic incidents in history.

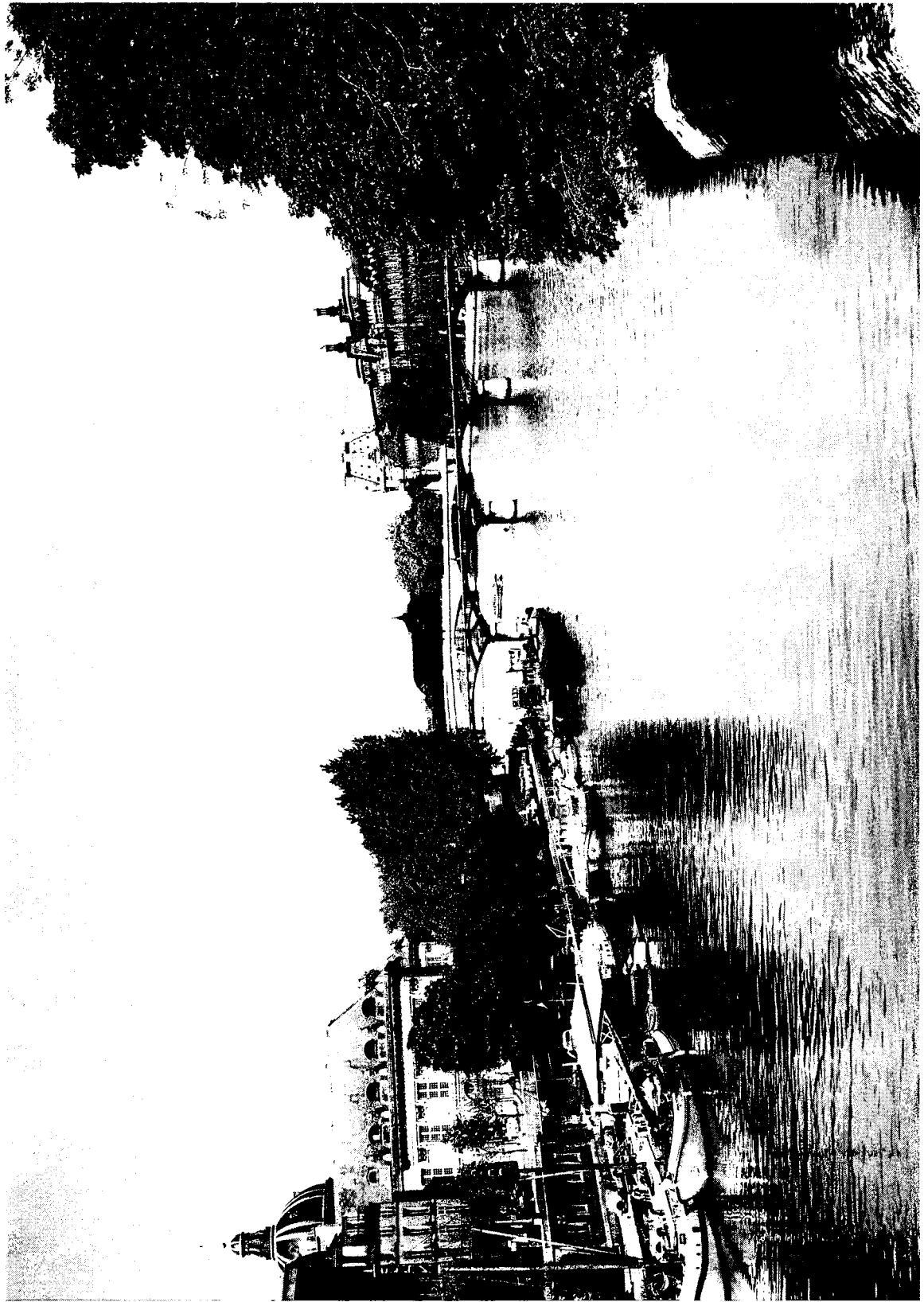
(Photo by AMORC)

**The  
Rosicrucian  
Digest  
April  
1978**

### **SHRINE AT DENDERA TEMPLE (overleaf)**

Shown here is the entrance to the Hathor Shrine at Dendera, Egypt. The goddess worshiped here was Hathor, whose head is seen on these columns. The goddess Hathor depicted woman's love and joy. However, according to ancient inscriptions, she was once ordered by the god Ra to destroy men who had plotted against him. Later, Ra repented and prevented Hathor from destroying the human race.

(Photo by AMORC)



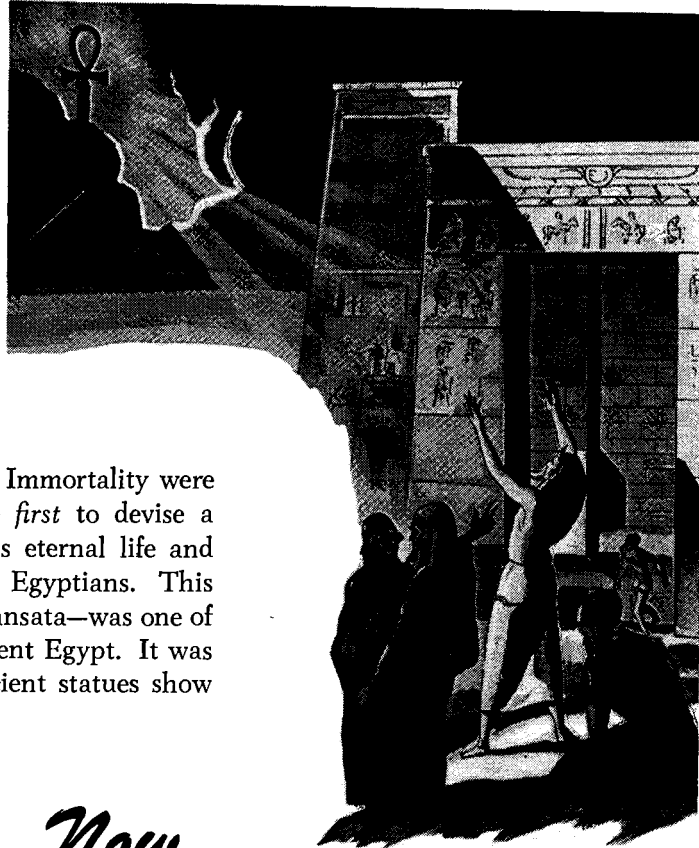




# CRUX ANSATA

## Egyptian Cross of Life

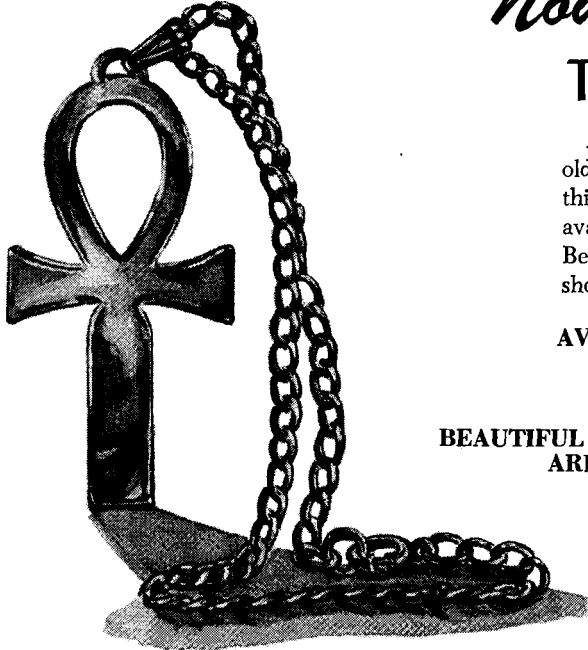
THE first to profess a belief in Immortality were the ancient Egyptians. The first to devise a cross as a symbol depicting this eternal life and moral values were the ancient Egyptians. This looped cross—the *ankh*, or crux ansata—was one of the most sacred symbols of ancient Egypt. It was always worn by pharaohs. Ancient statues show them holding this cross of life.



*Now...*

## This Exquisite Jewelry

After thousands of years, the crux ansata—the world's oldest cross—still has a tremendous appeal. It is a thing of beauty, mystery, and romance. Now it is available, accurately made according to ancient design. Beautifully finished in 10-karat gold. Illustration shown is *exact size*.



AVAILABLE IN TWO SIZES: (Chain not included)

3" (7.6 cm.) \$21.50\*  
1 1/4" (3 cm.) \$10.25\*\*

BEAUTIFUL 12K GOLD-FILLED TWISTED ROPE CHAINS  
ARE ALSO AVAILABLE IN TWO SIZES:

18" (46 cm.) \$10.75\*\*\*  
24" (60 cm.) \$13.25\*\*\*\*

Other Currencies:

\*\*\$21.50  
£11.31 A\$19.54 NZ\$21.50  
¥14.33 €26.87 R18.69

\*\*\*\$10.75  
£5.65 A\$9.77 NZ\$10.75  
¥7.16 €13.43 R9.34

\*\*\$10.25  
£5.39 A\$9.31 NZ\$10.25  
¥6.83 €12.81 R8.91

\*\*\*\*\$13.25  
£6.97 A\$12.04 NZ\$13.25  
¥8.83 €16.56 R11.52

California residents please add 6% sales tax.

Order and remit to:  
**ROSICRUCIAN SUPPLY BUREAU**  
San Jose, California 95191, U. S. A.

# DO YOU KNOW THE ANSWERS?



Do your friends and acquaintances gather around you with questions upon questions, when you mention the Rosicrucian teachings? Are you prepared to defend your statements with facts and experiences? Can you present the Rosicrucian viewpoint as clearly as you wish? If not, then you should read

## The ROSICRUCIAN FORUM

No other book, periodical or leader published by the Rosicrucian Order (AMORC) gives so much for so little. It is current, personal, clear, and meant for you. A private publication FOR MEMBERS ONLY. *The Rosicrucian Forum* gives you a confidential contact with the Supreme officers. Look at this list of just a few of the fascinating questions discussed in recent issues:

"Is Conscience Racial?" "What's Wrong With the World?" "Why Social Disorder?"  
 "Sacrificing for Others" "Limits of Psychic Development" "The Art of Meditation"

A whole year's subscription to the *Forum* costs only \$4.95. Begin your subscription now! Just mail your remittance with the order form below to:

**THE ROSICRUCIAN FORUM**  
 Rosicrucian Park San Jose, California 95191

THE ROSICRUCIAN FORUM  
 Rosicrucian Park, San Jose, California 95191  
 Gentlemen:

Enclosed is \$4.95 for a year's subscription to *The Rosicrucian Forum*. I understand this entitles me to six copies, one every other month.

Name ..... Key No. ....

Address .....

..... ZIP Code



Foreign Currency Equivalents  
 £2.75 A\$4.95 NZ\$4.95  
 ¥9.00 ₪6.20 R4.50

# BRAVE NEW ERA

**D**URING the late 1920s and all through the Depression years, there circulated the story of a bright young inventor who developed something called a "gasoline pill," which would convert plain water into high-octane fuel; all you had to do was fill your automobile's gasoline tank with tap water, add the pill, and drive away on a fuel which cost a fraction of the price of those pre-Arab oil cartel days. According to this story (and its innumerable versions) it is soon as the oil companies got wind of this, they conspired to buy the formula from the young man, to suppress it, making him an instant multimillionaire.

Thus the gasoline pill disappeared from the landscape, secreted away by the omnipotent monopolies that supposedly run this world, into that limbo inhabited by the ever-sharp razor blade, the battery that never loses its charge, and heaven knows what other inventions which would have been a boon to mankind but potential financial disasters to these mysterious powers behind the thrones.

Of course, all of this is nonsense . . . I think. Nevertheless, nonsense or not, reality seems to have a knack for catching up to fiction, for something similar may be about to happen (or may have already happened) to an inventor by the name of Stanford R. Ovshinsky.

Ovshinsky, founder and president of a small firm called Energy Conversion Devices, Inc., of Troy, Michigan, in the United States, developed some ten years ago, for the computer industry, what he called "Ovonic" materials. These materials' characteristics (amorphous solids with semiconducting properties) stunned the scientific world; however at the time, his new development had very limited applications, and the expected prosperity to his business never materialized.

Ovshinsky kept at it, and recently announced the modification of certain semiconductor devices to produce electricity from the Sun for as little as 0.2 cents per kilowatt hour. The cost of this material comes to about \$4.65 per square meter. When one considers that present commercial solar cells based on crystalline silicone cost between \$140 to \$230 a square meter, and generate power at a cost of about 50 cents per kilowatt hour, while conventional power sources do it at a cost of between four to seven cents per kilowatt hour, the implications of the Ovshinsky device are easy to see.

If the Ovshinsky device works as claimed by its inventor, then we would see realized the dream of each home having its own collection panel on the roof, inexpensively drawing abundant power from the Sun, thus preserving limited supplies of fossil fuels and preventing the spread of nuclear power plants. People would be independent from power poles, pipelines . . . and utility companies.

Ovshinsky states that although some of the engineering work still remains to be done, "application is a matter of investment, not invention." And therein lies the heart of the problem. . . .

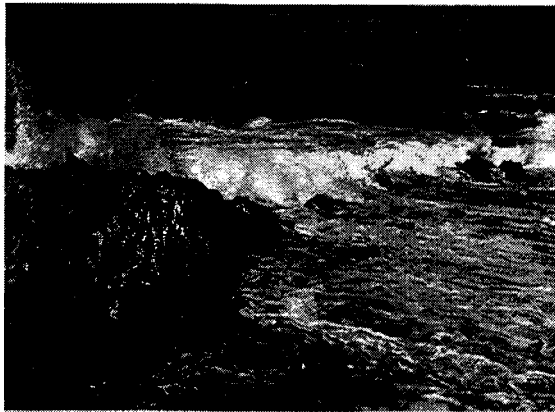
Back in 1968, when he first developed Ovonic materials, Ovshinsky over-extended himself. This forced him to turn to outside sources for capital in order to keep his company going. Last year, Ovshinsky's company lost well over a million dollars. Desperate to save his business, he sold half the rights to any solar devices to United Nuclear Corporation, a uranium producer, and is presently negotiating with Exxon Corporation to handle the marketing of the new solar devices.

What this all means is that even if the Ovshinsky system proves to be the breakthrough he claims it to be, making the direct conversion of solar power into electricity more than just competitive, by the time it reaches the market—when and if—it won't be under his sole ownership and control; in fact, he may already own very little of his own invention.

It's silly, of course, for no such place really exists, but one cannot help getting visions of a great secret museum where there awaits an empty display case, reserved for the Ovshinsky device, placed between the ones containing the legendary ever-sharp razor blade, the gasoline pill, the battery that never runs down, and who knows what other potentially useful inventions and technologies developed—and discarded for various reasons—during the course of this, our brave new era.—AEB

*(This article is being offered as a point of news but does not involve AMORC, nor necessarily represent the organization's viewpoint.)*





# ODYSSEY

John Muir  
Part III—Philosophy

"LIGHT. I know not a single word fine enough for Light . . . holy, beamless, bodiless, inaudible floods of Light." In these words John Muir expressed his lifelong fascination with *Light*. He was perpetually awed and excited by the ever-changing play of light across the face of nature—be it light refracted through a rainbow, sunlight playing across mountain peaks, or more subtle moonlight, caught for seconds in the dashing spray and ripples of mountain waterfalls. Sunlight playing through wind-driven clouds quickly changes the colors in a landscape—emphasizing particular hues, bringing them to the surface, while toning down and softening other colors. And, with clouds scudding across the sky, in moments the colors change again. Across the landscape, flowers reflect back all of this light, opening their beautiful blossoms to the Sun.

Through all this beauty, and through keeping in touch with his intuitive self and his high values, John Muir came to a higher understanding of man's place within nature. He understood the vital link between wilderness preservation and man's future. And this is more than a physical link—it's spiritual also. Wilderness is a vital part of ourselves and has much to teach us. Its beauty touches us deep within—touches the Soul—and in so touching, appeals to the higher aspects of man's nature.

Muir was not against improving man's life. As a young man he was an inventor—fascinated by the cogs and wheels of machinery. And many years later Muir was a successful orchardist in California.

However, Muir also spent much of his life tramping through the American wilderness. And he spent much of his time and energy awakening the American public to the rampant destruction of that wilderness. Through speaking and writing, Muir made the public more aware of what was going on, and the wilderness beauty they were about to lose **forever** if action was not taken soon. He spearheaded the conservationist movement. In 1903, when his beloved Yosemite was threatened with logging and further development, John Muir went camping in this beautiful area with President Theodore Roosevelt—personally guiding him through the beauty of Yosemite's mountains, domes, waterfalls, meadows, and giant sequoias. Among Roosevelt's comments:

*"Yesterday I saw for the first time a grove of your great trees, a grove which it has taken the ages several thousands of years to build up; and I feel most emphatically that we should not turn into shingles a tree that was old when the first Egyptian conqueror penetrated to the valley of the Euphrates. . . . That you may say is not looking at the matter from the practical standpoint. There is nothing more practical in the end than the preservation of beauty, than the preservation of anything that appeals to the higher emotions in mankind. . . ."*

The Roughrider was impressed, and later designated over one million acres of wilderness as National Parks and Forests. John Muir's good work lives on—perhaps best exemplified today in the increased spirit of conservation and ecological awareness throughout the land.—RMT

